

Contents

Important Information	1	In-Call Options	16
Safety Considerations	1	My Phone Menu Structure	19
SAR	3	My Phone	20
European Union - RTTE.....	3	Profile Setting	20
Care and Maintenance	4	Sound Setting	22
Getting Started	5	Display	26
Fitting and Removing the SIM	5	User messages	28
Fitting and Removing the Battery	5	Auto Answer.....	29
Charging the Battery	6	Any Key Answer.....	29
Operation of Battery Level Indicator	6	Reset Defaults	29
Low Battery Warning	6	Shortcuts	30
Keys & Displays	7	My Phonebook	30
Keys	7	T9 Text Input	30
Display.....	8	Game Menu Structure	31
Status Icons.....	8	Games	32
Symbols used in the Manual	9	Selecting Games	32
Menu Display	9	Phone Book Menu Structure	33
Menu Structure	10	Phone Book	34
Shortcut from Idle Screen	11	Storing	34
Phone Basics	12	Viewing	35
Phone ON/OFF	12	Options in Phone Book	35
Displaying Menu	12	Group Settings	36
Making Calls	13	Memory Status	37
Answering Calls	15	My Numbers	37

Hot Key Dial	38	CSD Setting	65
My Phonebook	38	GPRS Setting	66
Browser Menu Structure	39	GPRS Info	66
Browser	40	Applications Menu Structure	67
Server Setting	40	Applications	68
WAP Activating	41	Games	68
Bookmarks	42	Scheduler	69
Key Guard	43	Clock	70
Messages Menu Structure	44	Calculator	72
Messages	45	Currency	73
SMS	45	Melody Composer	73
Options	50	Sound Folder	74
Broadcast	51	Picture Folder	75
Auto Display	53	Records Menu Structure	76
Text Entry	54	Records	77
Shift mode	55	Troubleshooting	78
Tegic	55	Glossary of Terms	80
Text Input	55	Specifications	82
Phone Option Menu Structure	57	Accessories	83
Phone Option	58	Personal Settings	84
Call Service	58	Licencing	85
Call Divert	61	Index	86
Security	62	EU Warranty	90
Codes	63		
Network	65		

Important Information

Thank you for purchasing this Panasonic digital cellular phone. This phone is designed to operate on GSM networks – GSM900, GSM1800 and GSM1900. It also supports GPRS for packet data connections. Please ensure the battery is fully charged before use. We, Panasonic Mobile Communications Development of Europe Ltd., declare that the EB-G50 conforms with the essential and other relevant requirements of the directive 1999/5/EC.

A declaration of conformity to this effect can be found at <http://www.panasonicmobile.com>

Safety Considerations

The following information should be read and understood as it provides details which will enable you to operate your phone in a manner which is both safe to you and your environment, and conforms to legal requirements regarding the use of cellular phones.



This equipment should only be charged with approved charging equipment to ensure optimum performance and avoid damage to your phone. Other usage will invalidate any approval given to this apparatus and may be dangerous. Ensure the voltage rating of the Fast Travel Charger is compatible with the area of use when travelling abroad. A Fast Travel Charger (EB-CAD55xx*) is supplied with the Main Kit.

Note* xx identifies the Charger region, e.g. AU, CN, EU, UK, US



Use of another battery pack than that recommended by the manufacturer may result in a safety hazard.



If you use a feature which keeps the key backlight on continuously for a long time, such as a game or the browser, battery life will become extremely short. To maintain longer battery life, set the key backlight to off. See "Setting Brightness."



Switch off your cellular phone when in an aircraft. The use of cellular phones in an aircraft may be dangerous to the operation of the aircraft, disrupt the cellular network and may be illegal. Failure to observe this instruction may lead to the suspension or denial of cellular phone services to the offender, or legal action or both.



Do not incinerate or dispose of the battery as ordinary rubbish. The battery must be disposed of in accordance with local regulations and may be recycled.



It is advised not to use the equipment at a refuelling point. Users are reminded to observe restrictions on the use of radio equipment in fuel depots, chemical plants or where blasting operations are in progress. Never expose the battery to extreme temperatures (in excess of 60°C).



It is imperative that the driver exercises proper control of the vehicle at all times. Do not hold a phone while you are driving; find a safe place to stop first. Do not speak into a handsfree microphone if it will take your mind off the road. Always acquaint yourself thoroughly with restrictions concerning the use of cellular phones within the area where you are driving and observe them at all times.



Care must be taken when using the phone in close proximity to personal medical devices, such as pacemakers and hearing aids.



For most efficient use hold the phone as you would any normal phone. To avoid deterioration of signal quality or antenna performance, do not touch or “cup” the antenna area while the phone is switched on. (See “SAR Statement”.) Unauthorised modifications or attachments may damage the phone and violate applicable regulations. The use of an unapproved modification or attachment may result in the invalidation of your guarantee – this does not affect your statutory rights.

This equipment should only be used with Panasonic approved accessories to ensure optimum performance and avoid damage to your phone. Panasonic is not responsible for damage caused by using non-Panasonic approved accessories.

This Panasonic mobile phone is designed, manufactured and tested to ensure that it complies with the specifications covering RF exposure guidelines applicable at the time of manufacture, in accordance with EU, USA FCC and Australian ACA regulations; or as specifically stated in the separate declaration leaflet enclosed with this product.

Please refer to our website for latest information/standards and compliance in your country/region of use.
<http://www.panasonicmobile.com>

SAR

European Union - RTTE

THIS **PANASONIC PHONE (MODEL EB-G50)** MEETS THE EU REQUIREMENTS FOR EXPOSURE TO RADIO WAVES.

Your mobile phone is a radio transmitter and receiver. It is designed and manufactured not to exceed the limits for exposure to radio frequency (RF) energy recommended by The Council of the European Union. These limits are part of comprehensive guidelines and establish permitted levels of RF energy for the general population. The guidelines were developed by independent scientific organisations through periodic and thorough evaluation of scientific studies. The limits include a substantial safety margin designed to assure the safety of all persons, regardless of age and health.

The exposure standard for mobile phones employs a unit of measurement known as the Specific Absorption Rate or SAR. The SAR limit recommended by The Council of the European Union is 2.0 W/kg*. Tests for SAR have been conducted using standard operating positions with the phone transmitting at its highest certified power level in all tested frequency bands. Although the SAR is determined at the highest certified power level, the actual SAR level of the phone while operating can be well below the maximum value. This is because the phone is designed to operate at multiple power levels so as to use only the power required to reach the network. In general, the closer you are to a base station antenna, the lower the power output.

Before a phone model is available for sale to the public, compliance with the European R&TTE directive must be shown. This directive includes as one essential requirement the protection of the health and the safety for the user and any other person. The SAR value for this model phone, when tested for use at the ear, for compliance against the standard was 0.494 W/kg. While there may be differences between the SAR levels of various phones and at various positions, they all meet the EU requirements for RF exposure.

*The SAR limit for mobile phones used by the public is 2.0 watts/kilogram (W/kg) averaged over ten grams of tissue. The limit incorporates a substantial margin of safety to give additional protection for the public and to account for any variations in measurements. SAR values may vary depending on national reporting requirements and the network band.

For SAR information in other regions please look under product information at <http://www.panasonicmobile.com/health.html>

Care and Maintenance



Pressing any of the keys may produce a loud tone. Avoid holding the phone close to the ear while pressing the keys.



Extreme temperatures may have a temporary effect on the operation of your phone. This is normal and does not indicate a fault.

If you use the phone for a long time in temperatures over 40°C, the display quality may deteriorate.



Do not modify or disassemble the equipment. There are no user serviceable parts inside.



Do not subject the equipment to excessive vibration or shocks.

Do not drop the battery.



Avoid contact with liquids. If the equipment becomes wet, immediately remove the battery and contact your dealer.



Do not leave the equipment in direct sunlight or a humid, dusty or hot area.

Never throw a battery into a fire. It may explode.



Keep metallic items that may accidentally touch the terminals away from the equipment/battery.

Batteries can cause property damage, injury, or burns if terminals are touched with a conductive material (i.e. metal jewellery, keys, etc.).



Always charge the battery in a well ventilated area, not in direct sunlight, between +5°C and +35°C. It is not possible to recharge the battery if it is outside this temperature range.



When connecting the phone to an external source, read the operating instructions of the equipment for the correct connection and safety precautions. Ensure the phone is compatible with the product it is being connected to.



When disposing of any packing materials or old equipment check with your local authorities for information on recycling.

Getting Started

Some services detailed, are network dependent or may only be available on a subscription basis. Some functions are SIM dependent. For more information contact your service provider.

Fitting and Removing the SIM

The SIM is inserted under the battery.

Fitting the SIM



Removing the SIM

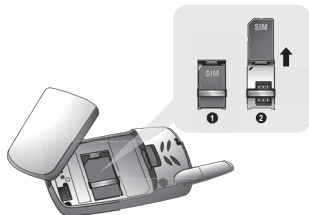

Fitting and Removing the Battery

Before removing the battery, ensure that the phone is switched off and the charger is disconnected from the phone.

Fitting the battery



Removing the battery

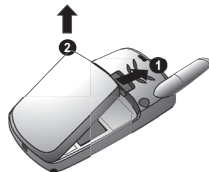

Charging the Battery

Connecting and disconnecting the Fast Travel Charger

The battery must be fitted in the phone before the charger is connected. Insert the charger into the base of the phone and connect the travel charger to the socket-outlet. Then the Battery Level Indicator will start scrolling. It is recommended to charge the battery for a minimum of 4 hours before first use.

NOTE: DO NOT force the connector as this may damage the phone and/or the charger. If the battery has been deeply discharged the phone will take a short time until the charge indicator displays.

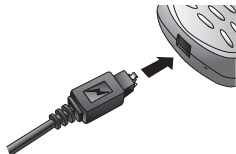

When charging is complete disconnect the charger from the wall socket before removing the plug from the Phone.



Operation of Battery Level Indicator

	While charging	Charging complete
Phone on		
Phone off		Battery Charge Indicator off

NOTE: When the battery is deeply discharged, it may take a short time (2 to 3 minutes) until charging starts.

Low Battery Warning

When the battery power is low, **Battery Is Low** message will be displayed. If this occurs during conversation, finish your call immediately. The power will automatically switch off after the warning tone. Fully recharge the battery. See "Charging the Battery" on this page. (Calls can be made and received while the phone is charging.)

Keys & Displays



Keys

Key	Function
	2-way Navigation Key: moving up/down/right/left through the options in the display area. In idle mode, entering to the Shortcuts.
	Left Softkey: Perform the functions displayed above the key. In idle, long press to enter to the SMS menu.
	Right Softkey/Cancel or Exit key: Perform the functions displayed above the key. Mainly used to cancel and returned to previous menu level, or to delete text/number entries. In idle, long press to enter the Profiles menu.
	Numeric key pads: Enter numbers. Press and hold a single key (1~9) for Speed Dial. In text entry mode, enter text, numbers and characters. Long press to enter a "+" or "P". When you need to dial an extension number, dial the phone number first then long press to add a "P" and enter the extension number.
	Send Key: Make a call or answer a call. In idle mode, check the last dialled list.
	Power/End Key: End/reject a call. During key operation, short press to return to the previous display. In idle mode, long press to switch phone on/off. In Browser mode, long press to end Browser mode.
	Asterisk Key: In idle, long press to activate Browser.
	Quiet Mode Key: In idle, long press to switch the Mute Mode on and off.

Display

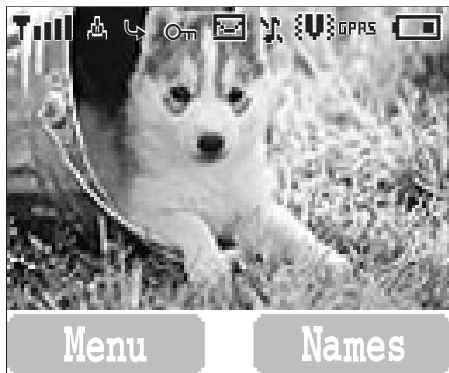

NOTE: All screen images in the manual are simulated.

Status Icons

The status icons are displayed or animated according to the currently activated functions. The Antenna, Signal and Battery icons are displayed when the handset is switched on and connected to a network. In the occasion of that network level is zero, the network icon will not be displayed.

Icon	Indication
	Registered to a non-home network - roaming
	Call divert is on
	Vibration alert is on
	Silent Mode is on
	Message area is full
 (Flashing)	Unread message is stored
	Key Guard is enabled
	Voice mail message
	Indicates it is possible to make emergency call
	SIM supports CPHS and Line1 is selected in Phone Option menu
	Signal strength
	Battery full level:
	- low battery
	Alarm is set
	GPRS is active

Symbols used in the Manual



Press the Navigation key in the direction indicated by the arrow



Press Left Soft Key



Press Right Soft Key



Press numeric key pads



Press to answer a call or call a dialled number



Press to end a call or long press to switch the phone on/off

Menu Display

The menu system provides the means for accessing the functions which do not have their own dedicated buttons on the keypad.

Entering to the Menu Display

From **idle screen**

1 (Menu)

The main menu display has 9 menu options.
(See "Menu Structure" on page 10.)

2 required menu (Select)

OR

pressing a numeric key will access a menu option directly.

Back to the Menu Display

repeatedly until the display goes back to the Menu display.

Menu Structure

The 9 main menus are as follows.



My Phone

- 1 Sounds
- 2 Display
- 3 Language
- 4 Alert Type
- 5 Profiles
- 6 User Messages
- 7 Auto Answer
- 8 Any Key Answer
- 9 Reset Defaults
- 10 Shortcuts
- 11 My Phonebook
- 12 T9 Input



Games (or STK)*

- 1 Fillip
- 2 Classic rally



Phone Book

- 1 Browse
- 2 Create
- 3 Group Settings
- 4 Memory Status
- 5 My Numbers
- 6 Hot Key Dial
- 7 My Phonebook



Browser

- 1 Start Browser
- 2 Bookmarks
- 3 Settings



Key Guard



Messages

- 1 Create
- 2 Inbox
- 3 Outbox
- 4 Archive
- 5 User Messages
- 6 Memory Status
- 7 Options
- 8 Broadcast



Phone Option

- 1 Call Service
- 2 Call Divert
- 3 Security
- 4 Network
- 5 CSD Setting
- 6 GPRS Setting
- 7 GPRS Info



Applications

- 1 Games
- 2 (STK)*
- 3 Scheduler
- 4 Clock
- 5 Calculator
- 6 Currency
- 7 Melody Composer
- 8 Sound Folder
- 9 Picture Folder



Records





- 1 Last Dialed
- 2 Answered
- 3 Unanswered
- 4 Erase Records

*STK(SIM Tool Kit) is SIM dependent.

Shortcut from Idle Screen







It is possible to enter the function directly from the Idle screen by pressing a key.

Short press

Key	Function
	Menu
	Phonebook* (Names)
	Shortcuts
	Last dialled record list

*The Phone must be registered with a network.

Long press



Key	Function
	Hot key dial
	
	Browser*
	Silent mode
	Profile menu
	Power on/off
	SMS Menu

*The Phone must be registered with a network.

Phone Basics



Phone ON/OFF

- 1 Press and hold  for 2 to 3 seconds
- 2  Phone will display Idle mode



- 3 Press and hold  again to turn the power off

Displaying Menu

- From idle mode
 to access Menu



- Menu will be displayed
 (Menu may change depending on your SIM)



Making Calls

> To make a call, start in Idle mode.

Standard Dialling

1 Enter phone number 

> The dialled number is displayed.

2 When the other party answers, talk into the Microphone.

3 To hang up, 

> The length of the call is displayed.

> When **Max Cost** is on, the remaining units will be displayed.



For setting the **Max Cost**, please refer to "Setting the Maximum Cost:" on page 60.

Earpiece Volume:

During a call,  to adjust earpiece volume

Phonebook Dialling

1  (Names)

2  required contact 



Last Number Dialling

- 1
- 2 required contact

International Dialling

The international access code (+) and the destination country/region code should be entered, followed by the area code and phone number.

- 1 Press and hold until "+" is displayed then enter country/region code
- 2 Enter area code and phone number

NOTE: Many countries/regions include an initial "0" in the area code. This should, in most cases, be omitted when dialling international numbers. If you have difficulties making international calls, contact your service provider.

Emergency Call

To make an emergency call, the antenna () must be present

When SIM is installed:

enter emergency number 112

When SIM is not installed:

enter emergency number 112

OR

(SOS) > "Emergency Call" (Yes)

NOTE: Making Emergency calls without a SIM installed is country or network operator dependent.



Answering Calls



OR

When “Any Key Answer” is ON,



From Idle menu



press any key except 

(See “Setting Any Key Answer” on page 29)

Ring Volume:

From **My Phone** menu

1  **Sounds > Volume**  (Select)

2  Adjust the volume level  (OK)



Quick Touch Silent Mode:







To quickly set the ring tone off and the vibrator on, press and hold  in idle mode.

•  and  will be displayed on the idle screen.



In-Call Options

During a call,  (Menu) or  (Hold)



 (Menu)	Hands Free	Switch to Desktop Hands Free
	Conference	Enable to make a conference call. You can talk with up to 5 parties.
	Call Transfer	Connect your calling party to the other party you are holding, then disconnect your line. (SIM dependent)
	Call Status	 (End) to disconnect a line with the activating party.  (Hold) to put a call on hold with the activating party. To resume,  (Back) again.
	Phone Book	Open SIM Phonebook or Mobile Phonebook
 (Hold)	Hold	Put a call on hold. To resume,  (Back). (SIM dependent)

Desktop Handsfree

Desktop Handsfree allows you to hold a conversation without holding the phone to your ear.



NOTE: Do NOT hold the phone to your ear in Handsfree mode.

During a Handheld call:

-  (Menu)
-  **Hands Free**  (Select)

NOTE: You can also switch between Handheld and Handsfree by pressing and holding  #*.

To return to Handheld call:

 (Menu) >  (Select) to revert for Handheld operation



DTMF Tones

DTMF tones can be sent during conversation. These are often used to access voice mail, paging and computerised home banking. For example, you may need to input a number to remotely access voice mail messages. A phone number may be stored in Phone Book with DTMF tones, allowing the number to be dialled upon recall and the DTMF number to be sent automatically.

Send DTMF Tones During a Call:

Enter digits (0 + ~ 9 wxyz , # * , *)

Pause Dial

Using pauses allows you to send DTMF tones automatically.

- 1 Enter phone number
- 2 Press and hold 0 + until a **P** is displayed at the end of the phone number entered
- 3 Enter DTMF digits after the pause, e.g. enter the number to access voice mail messages
- 4 





When the call is connected DTMF tones will be sent after 3 seconds.





Incoming Call While in a Call

NOTE: Call waiting must be on - see "Setting Call Waiting" on page 58.
Call waiting is network dependent.

During a call, you may receive another call:

- 1 To answer another call,  (First call is placed on hold.)
To disconnect another call,  (Reject)
- 2 During a conversation with a second caller,  (Menu) or  (Swap) and select one from the following options:

 (Menu)	Hands Free	Switch to Desktop Hands Free
	Conference	Enable to make a conference call. You can talk with up to 5 parties.
	Call Transfer	Connect your calling party to the other party you are holding, then disconnect your line. (SIM dependent)
	Phonebook	Open SIM Phonebook or Mobile Phonebook
 (Swap)	Swap	Switch between two connected calls

To end a conference call and all connections: 

Making a Second Call

During a call:

Enter second phone number or recall it from Phone Book 
The first call is put on hold.

NOTE: Making a second call is network dependent.

My Phone Menu Structure

My Phone

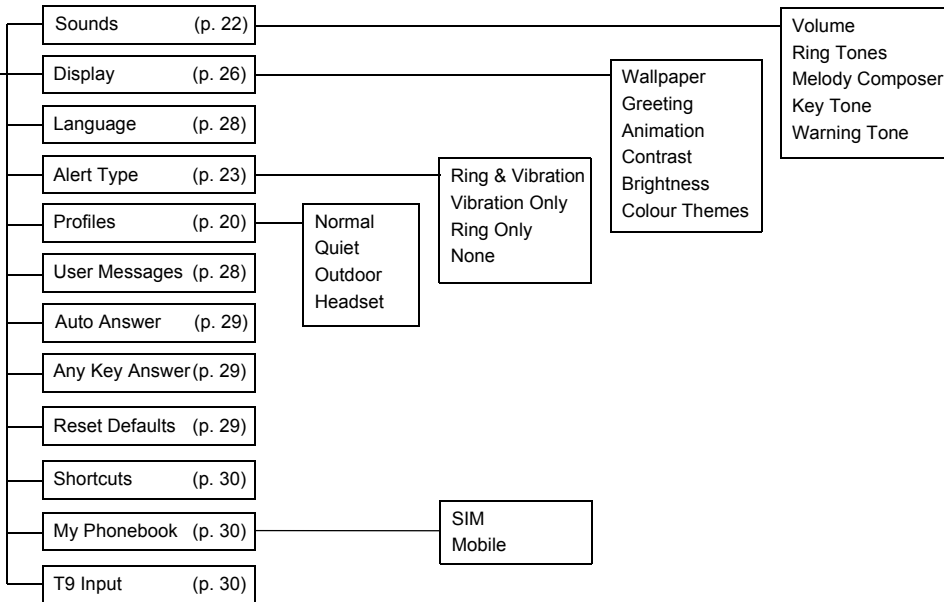







My Phone

You can switch between four profiles in your phone each with a distinct combination of alert method, ring tone, etc. Profiles are set up for use in different environments – for instance you might want to create **Normal** profile for everyday setting, **Quiet** profile with ring tone appropriate for formal occasions, **Outdoor** profile for loud environments and **Headset** profile with vibrator when it is difficult to hear the ring tone.

Profile Setting

Activating a profile.....

From **My Phone** menu



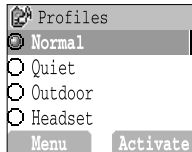







- 1  **Profiles**  (Select)
- 2  required profile  (Menu)
- 3  **Activate**  (Select)



Editing profiles.....

Ring Volume

From **My Phone** menu

- 1  **Profiles**  (Select)
- 2  required profile  (Menu)
- 3  **Change Settings**  (Select)
- 4  **Ring Volume**  (Select)
- 5  Adjust volume level  (OK)

Key Tone

From **My Phone** menu

- 1 **Profiles** (Select)
- 2 required profile (Menu)
- 3 **Change Settings** (Select)
- 4 **Key Tone** (On/off)

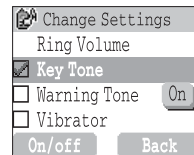

Warning Tone

From **My Phone** menu

- 1 **Profiles** (Select)
- 2 required profile (Menu)
- 3 **Change Settings** (Select)
- 4 **Warning Tone** (On/off)

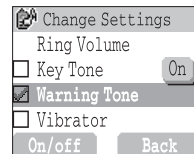

Vibrator

From **My Phone** menu

- 1 **Profiles** (Select)
- 2 required profile (Menu)
- 3 **Change Settings** (Select)
- 4 **Vibrator** (On/off)

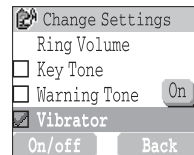

BrightnessFrom **My Phone** menu

- 1 **Profiles** (Select)
- 2 required profile (Menu)
- 3 **Change Settings** (Select)
- 4 **Brightness** (Select)
- 5 **Medium, High, Maximum or Low** (Select)

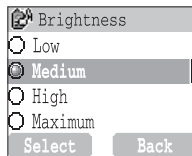
**Sound Setting**

Changing the Volume

From **My Phone** menu

- 1 **Sounds** (Select)
- 2 **Volume** (Select)
- 3 Adjust the volume level (OK)

Changing the Ring Tone.....

From **My Phone** menu

- 1 **Sounds** (Select)
- 2 **Ring Tones** (Select)
- 3 **Any Call, Group Calls, Alarm or Messages** (Select)
- 4 required ring tone (Select)

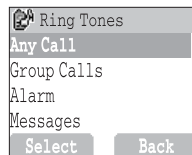

Setting Key Tone

From **My Phone** menu

- 1 **Sounds** (Select)
- 2 **Key Tone** (On/off)

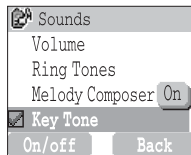

Setting Warning Tone.....

From **My Phone** menu

- 1 **Sounds** (Select)
- 2 **Warning Tone** (On/off)

Changing Alert Type.....

From **My Phone** menu

- 1 **Alert Type** (Select)
- 2 required Alert type (Select)

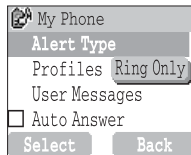

When required, the phone can be set up to vibrate and/or ring when a call is received.

You can change Alert Type:

- **Ring & Vibration**
- **Vibration Only**
- **Ring Only**
- **None**

Composing a Melody.....

From **My Phone** menu

- 1 **Sounds** (Select)
- 2 **Melody Composer** (Select)
- 3 required MyMusic (Menu)
- 4 **Edit** (Select)
- 5 required track (Menu)
- 6 Compose your melody - See the notes chart below > (Menu)
- 7 **Save** (Select)

You can arrange the **Tempo** and select an instrument (**Select Instrument**) before saving.











Using the following table as a reference, enter the notes (from the choice of low, middle and high), rests, and the duration of each, to generate your composition.

Main Track and Sub Tracks will be combined when you return to **MyMusic**.

Key	1	2 abc	3 def	4 ghi	5 jkl	6 mno	7 pqrs	8 tuv
Func	C	D	E	F	G	A	B	Rep.
Key	9 wxyz	0 +	*	# %				
Func	Dotted note	Rest	Duration	Low # Middle # High #				







Rename a melody:

From My Phone menu

- 1  **Sounds**  (Select)
- 2  **Melody Composer**  (Select)
- 3  required music  (Menu)
- 4 **Rename**  (Select)
- 5 Enter a name
 - To erase a letter,  (Clear).
 - To erase all letters, press and hold  (Clear).
- 6  (OK)







Set to Ringtone:

From My Phone menu

- 1  **Sounds**  (Select)
- 2  **Melody Composer**  (Select)
- 3  required music  (Menu)
- 4 **Set to Ringtone**  (Select)

Viewing a melody information:

From My Phone menu







- 1  **Sounds**  (Select)
- 2  **Melody Composer**  (Select)
- 3  required music  (Menu)
- 4 **Info** (Select)

You can change the Idle mode wallpaper displayed.

Display

Setting Wallpaper.....







From **My Phone** menu

- 1  **Display**  (Select)
- 2  **Wallpaper**  (Select)
- 3  required Wallpaper  (Select)
- 4  (On/off)

You can create a greeting message each time your phone is powered on.

Setting Greeting.....

From **My Phone** menu



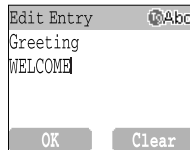



- 1  **Display**  (Select)
- 2  **Greeting**  (Edit)
- 3 Enter the Greeting  (OK)
- 4  (On/off)



You can change the displays power on Animation Theme.

Setting Display Animation.....





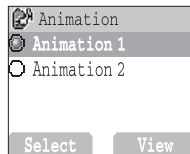

From **My Phone** menu

- 1  **Display**  (Select)
- 2  **Animation**  (Select)
- 3  required Animation  (Select)









Setting Display Contrast.....

From **My Phone** menu

- 1  **Display**  (Select)
- 2  **Contrast**  (Select)
- 3  Adjust the contrast  (OK)

Setting Brightness

From **My Phone** menu



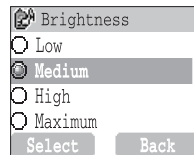



- 1  **Display**  (Select)
- 2  **Brightness**  (Select)
- 3  required level  (Select)



The Display's Colour Themes can be changed.

Setting Colour Themes.....

From **My Phone** menu

- 1  **Display**  (Select)
- 2  **Colour Themes**  (Select)
- 3  required colour  (Select)

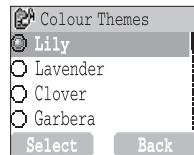

It is possible to change the language that the phone uses for display messages.

Changing the Language.....

From **My Phone** menu

- 1 **Language** (Select)
- 2 required language (Select)

User messages

There are 10 pre-set common user messages and 5 empty spaces for you to create your own messages. You can also set User Messages at **User Messages** in **Message** menu - see "Editing User Messages" on page 46

Editing User Messages

From **My Phone** menu

- 1 **User Messages** (Select)
- 2 required message or empty space (Select)
- 3 Enter your message (Menu)
 - To erase a letter, (Clear).
 - To erase all letters, press and hold (Clear).
- 4 **Save and Send** or **Save** (Select)
- 5 When **Save and Send** is selected, enter destination phone number (OK)

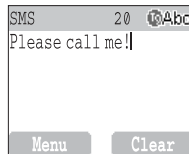

NOTE: If the text is wider than the screen display, the text will scroll.

Auto Answer

Auto Answer can be set but only functions when a Personal Handsfree Earpiece is used.

Setting Auto Answer

From **My Phone** menu

⓪ **Auto Answer** (On/off)

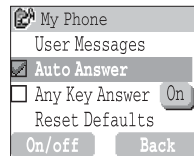

Any Key Answer

Calls can be answered by pressing any key (except ) .

Setting Any Key Answer

From **My Phone** menu

⓪ **Any Key Answer** (On/off)

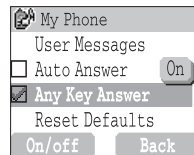

Reset Defaults

Any personal settings can be returned to their factory default settings.

Reset Defaults.....

From **My Phone** menu

1 ⓪ **Reset Defaults** (Select)

2 **"Restore Factory Settings?"** (No) or (Yes)

You can select any of the following options: **Browser, Games, Phone Book, Language, Alert Type, Sounds, Wallpaper, Profiles, Alarm, Calculator, Scheduler, Inbox, Create, Clock Setting and Currency** to appear in your shortcuts menu





You need to select which phonebook is to be used, SIM Phonebook or Mobile Phonebook. You can also set My Phonebook at **My Phonebook in Phonebook** - see "My Phonebook" on page 38.

Using this mode of text entry dramatically reduces the number of key presses required:

Shortcuts



Setting Shortcuts.....

From **My Phone** menu

- 1  **Shortcuts**  (Select)
- 2  required shortcuts  (On/off)

Access to Shortcuts:

From Idle mode

- 1  required shortcuts  (Select)

My Phonebook

Setting SIM or Mobile Phonebook

From **My Phone** menu



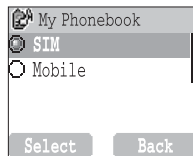





- 1  **My Phonebook**  (Select)
- 2  **SIM or Mobile**  (Select)



T9 Text Input

Setting T9 Text Input

From **My Phone** menu

- 1  **T9 Input**  (Select)
- 2  Set **T9 Prefer** on  (On/off)
- 3  **Input Language**  (Select)
- 4  required language  (Select)

See "Shift mode" on page 55 for detail.

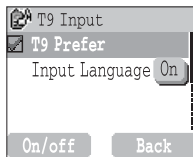

Games Menu Structure

Games (or STK)*

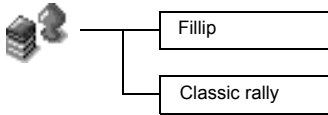

* STK (SIM Tool Kit) is SIM dependent.

Games

The parts are scattered far and wide and some are stuck in the treetops where aggressive mosquitoes and grouchy birds live, and some have fallen into the water, where they are guarded by fierce piranhas.

The car can slide in the turns if you drive too fast and behaves like a real car. Drive your car as fast as you can. When you pass all the stations, you will get a score.

Selecting Games

From **Games** menu

⏏ required game (Select) from **Fillip** and **Classic rally**.

NOTE: Once the power is turned off, High scores or Best scores are lost.

Fillip.....

Key Operation:

⏏₄ ghi (move left), ⏏₆ mno (move right), ⏏₂ abc (jump), ⏏₁ (jump left),
⏏₃ def (jump right).

Starting Games:

Select **Start game** by using ⏏ (or ⏏₂ abc (Up) and ⏏₈ tuv (Down)), then
⏏₅ jkl (Select).



Classic rally

Key Operation:

⏏₂ abc (Forward), ⏏₄ ghi (Turn Left), ⏏₆ mno (Turn Right), ⏏₈ tuv (Backward) to move the car.

Starting Games:

- 1 Select Start Game by pressing any numeric key except ⏏₀ +
- 2 To choose your car, ⏏₁ (or ⏏₄ ghi or ⏏₆ mno), then ⏏₅ jkl (Select).
To choose a race course, ⏏₁ (or ⏏₄ ghi or ⏏₆ mno), then ⏏₅ jkl (Select)

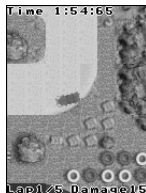

NOTE: If SIM card provides SIM Tool Kit services, this menu will become the STK Menu. You can still access Games from Applications.

Phone Book Menu Structure

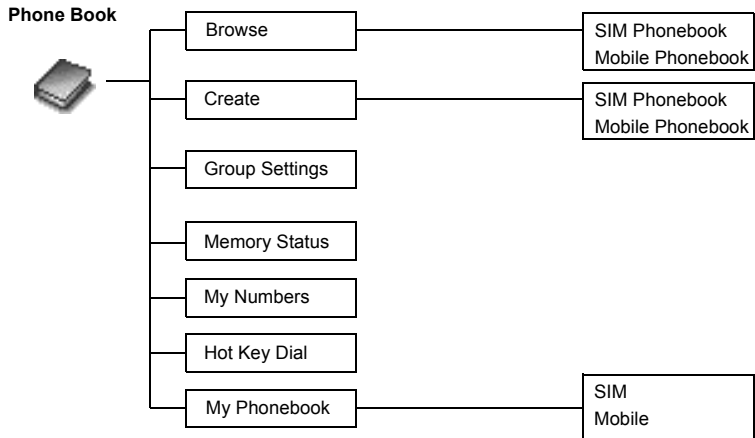

Phone Book

Storing

Phone numbers can be stored in SIM or in your phone.

In the SIM, you can store or select:

- Phone number
- Name

Storing a Number in SIM

From **Phone Book** menu

- 1 **Create** (Select)
- 2 **SIM Phonebook** (Select)
- 3 Enter **Name** > **Phone number**
- 4 (Save)
 - "Saved in SIM" is displayed.

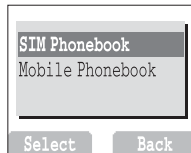

NOTE: The length and amount of data is SIM dependent.

In the phone, you can store:

- Name
- 3 Phone Numbers (Phone, office, mobile)
- Caller's ID
- Groups
- Melodies

The entries can be grouped together and these are retained even if you damage the SIM.

Storing a Number in Mobile Phonebook.....

From **Phone Book** menu

- 1 **Create** (Select)
- 2 **Mobile Phonebook** (Select)
- 3 Enter **Name**
- 4 Enter Phone number (**Phone, Tel./office, Tel./mobile**)
- 5 (Set) required **Caller's ID Image** (Select)
- 6 (Set) required group (Select)
- 7 (Set) required melody (Select)
- 8 When entries are completed, (Save)
 - "Saved in Mobile" is displayed.

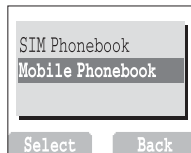





You can search Phonebook by name.

Viewing





Browsing the Phone Book

From **Phone Book** menu

- 1  **Browse** > **SIM Phonebook** or **Mobile Phonebook**  (Select)
- 2  Search the name you wish to browse  (View)

Options in Phone Book

From **Phone Book** menu

- 1  **Browse** > **SIM Phonebook** or **Mobile Phonebook**  (Select)
- 2  required contact  (Menu)

The following options are available by pressing  (Select)

Edit	Edit the selected Phone Book entry
Delete	Delete the selected Phone Book entry
Delete All	Delete all Phone Book entries
Copy to Mobile/SIM	Copy a contact to Mobile/SIM Phonebook
Copy All to Mobile/SIM	Copy all Phone Book to Mobile/SIM Phonebook
Search	Search for a desired item in Mobile/SIM Phonebook by entering the name.





Group Settings

The ability to group phonebook entries together is an extra function of the Mobile Phonebook.

Groups are used to collect together types of Contacts entries, e.g. Colleagues and Friends.

You can select a particular sound to the groups to identify them.

From **Phone Book** menu

- 1  **Group Settings**  (Select)
- 2  required **Group**  (Menu)

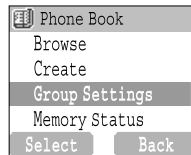

The following options are available by pressing  (Select)

View Group	View Phone Book entry in the selected group
Set Ring Tone	Set required ring tone
Remove Entries	Delete all Phone Book entries in the selected group

After selecting required **Group** in step 2, you can view a Phone Book entries by pressing  (View).

When there is no entry has been stored in the selecting group, "List Empty" is displayed.

The following options are available by pressing  (Menu)

Edit	Edit the selected Phone Book entry
Delete	Delete the selected Phone Book entry
Search	Search for a desired item in the selected group by entering the name.

Memory Status

Memory status shows how many locations are available in the Phone Book.

Viewing Memory Status.....

From **Phone Book** menu

1 **Memory Status** (Select)

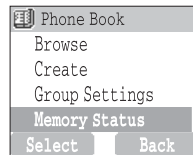

My Numbers

My Number is a phonebook where you can store your numbers.

Setting My Numbers.....

From **Phone Book** menu

1 **My Numbers** (Select)

2 required entry (Menu)

3 **Edit** (Select)

4 Enter your phone number

5 Enter your name (Save)

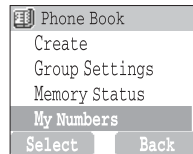

Viewing My Numbers.....

From **Phone Book** menu

1 **My Numbers** (Select)

2 required entry (View)

Phone numbers stored at locations 001 - 009 in the Phonebook can be dialed quickly.

Hot Key Dial

Setting Hot Key Dial

From **Phone Book** menu

1  **Hot Key Dial**  (On/off)

NOTE: This function is available only when a SIM is installed.

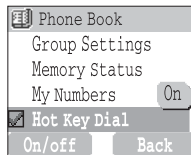

Making a Call by Using Hot Key Dial

From **Idle** mode

1 Press and hold a digit key (1~9)

2 Press 

My Phonebook

This option allows you to select which phonebook will be displayed. SIM or Mobile.

From **Phone Book** menu

1  **My Phonebook**  (Select)

2  **SIM or Mobile**  (Select)

• Please refer to "My Phonebook" on page 30.

Browser Menu Structure

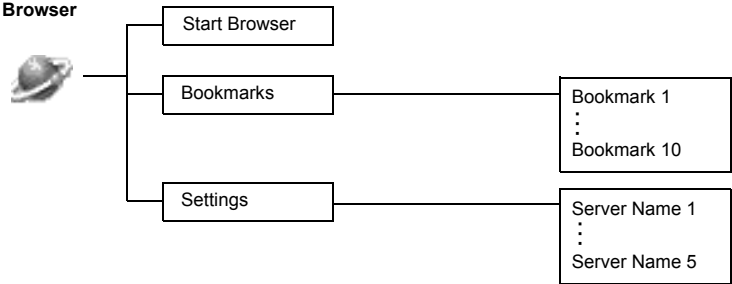

Browser





The phone's WAP (Wireless Application Protocol) Browser enables you to access Internet services supported by the network, such as news, weather reports, sport etc.

Server Setting

Before Internet services can be accessed, you need to subscribe to your network operator or Internet Service Provider (ISP) to enable the relevant configuration information. Please contact your network service provider to ensure that your network settings are correct.

NOTE: Modifying previously entered settings can cause failure of the Browser.



From **Browser** menu

- 1  **Settings**  (Select)
- 2  to select required server  (Edit)

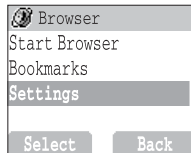
Five server settings can be set up in the phone. If you find your server's name under the settings option, select the server and  (Edit). If no settings are present contact your Network Service Provider for these settings. (Server Name, IP Address, IP Port, Homepage, Linger Time, Select Mode)







NOTE: You need to set **CSD Setting** or **GPRS Setting** in Phone Option before setting the server information.

Those configuration Options will be given by your network service provider. Once completing the entry, press  (Save) then press  (Activate).

The first time that the browser is activated there will be no content stored so the Home URL content will be displayed (as defined by the network operator). The Home URL will be recalled from the cache, each time the browser is activated. (Cache is the phone's memory that stores content downloaded in the past).

WAP Activating

From **Browser** menu

- 1  **Start Browser**  (Select)
- 2 Please follow to the instructions on the display.
 - While browsing a homepage, press  and you can select the following menus.
 - To end Browser, press and hold .

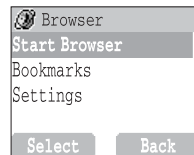

Home	Jump to the homepage which is set in Settings
Bookmarks	Select one from your setting bookmarks and jump
Save Items	Save items in your browsing homepages
Reload	Reload the browsing homepage
Go To URL	Enter a URL and jump to the homepage
Show URL	Display the URL of the browsing page
SnapShots	Capture the screen of your browsing page
Advanced	Inbox , Restart Browser and About are available to select
Settings	Scroll Mode , Downloads , Security and Send Referrer are available to set







Once you bookmark your favourite page, you can quickly jump to the page.

Bookmarks





Setting Bookmark

Entering URL from Browser menu:

From **Browser** menu

- 1  **Bookmarks**  (Select)
- 2  required empty Bookmark  (Menu)
- 3  **Edit**  (Select)
- 4 Enter Title and URL  (Save)

Setting Bookmark from Homepage:

- 1  >  **Bookmarks**
- 2 **Mark Site** > 
- 3 Enter **Folder** and **URL**
- 4  (Save)

Browsing Bookmark.....

From **Browser** menu

- 1  **Bookmarks**  (Select)
- 2  required Bookmark  (Launch)

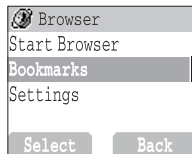



Key Guard

The Key Guard function is used to prevent any keys from being accidentally pressed e.g. when the phone is being carried.

Setting Key Guard

From **Key Guard** menu

 (Yes) or  (No)

- When Key Guard is enabled,  appears on the display.
- Emergency calls still can be made.
- When a call is received Key Guard will be disabled temporarily, allowing the user to answer the call.



NOTE: When making emergency calls with the "Key Guard" enabled, there will be no visual indication that the number is being dialed

Disabling Key Guard

When  appears on the display,

1  (Free)

2 "Press OK to Free keypad"  (OK)

Messages Menu Structure

Messages

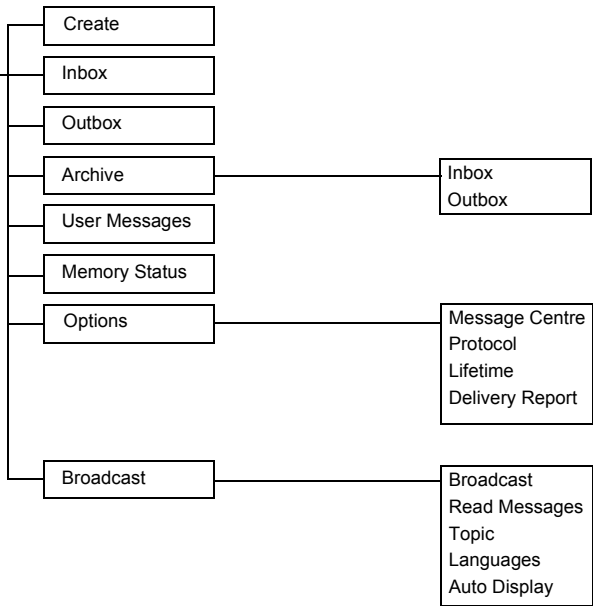

Messages

It is possible to receive, display, edit and/or send text messages of up to 1520 characters in ten messages (Dependent upon the language being used), to any network that has a roaming agreement. (Dependent on the recipient's phone Options.) Before sending a message, you need to enter the Message Centre number into Options.

SMS

Setting the Message Centre Number.....

From **Messages** menu

- 1 **Options** > **Message Centre** (Select)
- 2 Enter message centre number in international dial format
(see "International Dialling" on page 14) (OK)

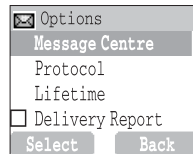

NOTE: Your network operator may have pre-installed this number. Do not change this number as it may cause failure of SMS Messaging.

Creating a New Short Text Message.....

From **Messages** menu

- 1 **Create** (Select)
- 2 Create your text message – max. 1520 characters
(see "Text Entry", page 54) (Menu)
- 3 **Send** (Select)
- 4 Enter the destination phone number (OK)
OR
Recall a number from the Phonebook (Names) >
 required name (Select) > (OK)

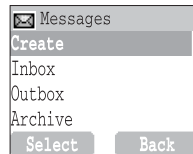







When you create a text, these options are available by  (Menu).

Send	Send a text as Short Text message
Save	Save a text in Outbox in SIM
Save and Send	Save a text in the Outbox in SIM and send
Picture & Sound	Add picture and/or sound to a text
User Messages	Use a short message stored in this phone For editing the User Message, see “Editing User Messages” below

Editing User Messages

From **Messages** menu

- 1  **User Messages**  (Select)
- 2  required message  (Select)
- 3 Edit the message  (Menu)
-  **Save** or **Save and Send**  (Select)

NOTE: If the text is wider than the screen display, the text will scroll.

When a Short Text Message is received, the message indicator will flash on the display and a user preset audible alert will be heard. If you are in a call you will be alerted by the vibrator.

✉ flashes when an unread message is received in the Inbox.
When the Inbox is full, ✉ will remain permanent until old messages are deleted.

Reading a Received Message

From **Messages** menu

- 1  **Inbox**  (Select)
- 2  required message  (Read)

- **Inbox:** The received message will be stored in **Inbox**.

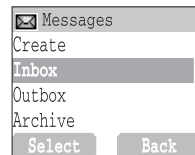

NOTE: If the message indicator is displayed constantly (does not flash), this means that the message area is full and you need to delete old messages in order to receive new messages.

When reading messages, the following options are available by  (Menu)



Delete	Delete a message
Reply	Create a replying SMS
Forward	Forward a message to another phone
Edit	Edit a message and save and/or send to another
Delete All	Delete all messages in Inbox
Extract Number	Extract numbers in messages and save in Phonebook
Move to Archive	Move a message into Inbox in Archive
Hyper Link	Link to a URL in a received message



Viewing Message Lists in Outbox.....

To view message lists which are stored in SIM.

- Outbox: The transmitted message will be stored in **Outbox**.

From **Message** menu

1  **Outbox**  (Select)

2  required message  (Read)

When reading a message, the following options are available by  (Menu)





Delete	Delete a message
Edit	Edit a message and save and/or send to another
Send	Send a SMS message after entering a recipient number
Delete All	Delete all messages in Inbox
Extract Number	Extract numbers in messages and save in Phonebook
Move to Archive	Move a message from Outbox to Outbox in Archive

Viewing Message Lists in Archive

To view message lists which are stored in Archive.

- Inbox: When the message received in Inbox is saved, the message will be saved to **Inbox** in **Archive**.
- Outbox: When the transmitted message in Outbox is saved, the message will be saved to **Outbox** in **Archive**.

From **Message** menu

- 1 **Archive**  (Select)
- 2  **Inbox/Outbox**  (Select)
- 3  required message  (Select)

When reading a message, the following options are available by  (Menu)

Delete	Delete a message
Edit	Edit a message and save and/or send to another
Forward(Inbox)/ Send (Outbox)	Forward/Send a message to another phone
Delete All	Delete all messages in Inbox

Memory status shows how many locations are left to store messages in the Inbox.

Viewing Memory Status.....

From **Messages** menu

 **Memory Status**  (Select)

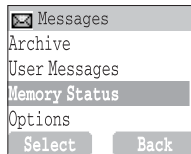

Options

Setting Options.....

From **Messages** menu

 **Options**  (Select)

NOTE: In the area where GPRS is not supported, SMS may not be sent when **SMS via GPRS** is on.

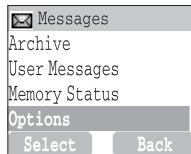

The following options are available:

Message Centre	Edit Message Centre number
Protocol	Select required Message Type from Standard Text, Fax, X.400, Paging, E-mail, ERMES, Voicemail
Lifetime	Select maximum or choose a time limit for sending messages
Delivery Report	Request a delivery report on the status of a sent message
SMS via GPRS	Send a Short Text message via GPRS

Broadcast

You can receive your favourite information regularly from your service provider.

You need to specify the "topic(s)" of information and the language that you wish to receive as broadcasts and tick the "Broadcast" on before you can receive them.

Setting Broadcast.....

From **Messages** menu

- 1 **Broadcast** (Select)
- 2 **Broadcast** (On/off)

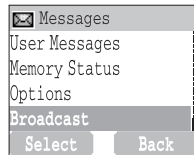

Setting Topic

From **Messages** menu

- 1 **Broadcast** > **Topic** > **Current** > (Select)
- 2 required **Topic** (Menu)
- 3 **Add or Delete** (Select)

Setting User defined Topic.....

From **Messages** menu

- 1 **Broadcast** > **Topic** > **User Defined** > **<New entry>** (Select)
- 2 **Enter Msg ID** (OK)
- 3 **Enter Name** (OK)
- 4 **Current** (Select)
- 5 **<Add Topic>** (Select)
- 6 required **Topic** (Select)

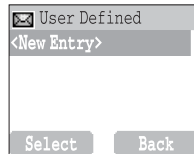

Setting Language.....

From **Messages** menu

- 1 **Broadcast** (Select)
- 2 **Languages** (Select)
- 3 required Language (Select)
- 4 To continue to add languages;
 Insert (Select)
 To complete adding language;
 Add to End (Select)

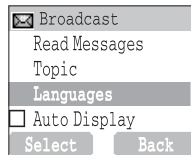

Viewing Broadcast.....

From **Messages** menu

- 1 **Broadcast > Read Messages** (Select)
- 2 To scroll to the available topics (Next)

NOTE: This function will depend on your Network Service Operator.

In idle mode, the latest Info Message is displayed on your phone automatically.

Auto Display

Setting Auto Display





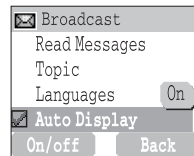







From **Messages** menu

- 1  **Broadcast**  (Select)
- 2  **Auto Display**  (On/off)



Text Entry

You can use alphanumeric characters to enter details into the Phonebook, to create text, etc.

Key	Text Mode		Numeric (0 ~ 9)
	T9®(T9Abc, T9ABC, T9abc) (Input language: English)	Multi tap (Input mode indicator: Abc, ABC or abc)	
 0 +	Punctuation 1	Space 0 . , ? ! + - = : ; ' " ' ; _	0
 1	Punctuation 2	1 / () < > [] { } & % ~ £ &	1
 2 abc	A B C (a b c)	A B C 2 Ä (a b c 2 ä à ç)	2
 3 def	D E F (d e f)	D E F 3 É (d e f 3 é è)	3
 4 ghi	G H I (g h i)	G H I 4 (g h i 4 í)	4
 5 jkl	J K L (j k l)	J K L 5 (j k l 5)	5
 6 mno	M N O (m n o)	M N O 6 Ö Ñ (m n o 6 ö ñ ò)	6
 7 pqrs	P Q R S (p q r s)	P Q R S 7 (p q r s 7 ß)	7
 8 tuv	T U V (t u v)	T U V 8 Ü (t u v 8 ú ù)	8
 9 wxyz	W X Y Z (w x y z)	W X Y Z 9 Æ Ø Å (w x y z 9 æ ø å)	9
	Shift mode	Shift mode	
 *	* Γ Δ Θ Λ Ξ Π Σ Φ Ψ Ω	* Γ Δ Θ Λ Ξ Π Σ Φ Ψ Ω	*
 #	Alternatives / (Hold) Space # £ \$ ¥ ¢ @ \ \$ ^	Alternatives / (Hold) Space # £ \$ ¥ ¢ @ \ \$ ^	#

Note: Displayed characters of T9® vary depending on the selected input language.

Shift mode

Shift mode change

The Shift mode changes by pressing (within 1 sec) .

Multi tap	Tegic
Abc -> ABC -> abc	T9Abc -> T9ABC -> T9abc

If Input mode is changed, Shift mode is initialised.

Auto capital change.....

Auto capital affects Abc and T9Abc.

If Input mode is changed to Abc or T9Abc, the first character is input as upper case and subsequent letters as lower case.

(Input mode indicator changes to abc or T9.)

If these characters [. (Period) or ! or ?] are input, the next character is input as upper case. (Input mode indicator changes to Abc or T9Abc.)

Tegic

User Dictionary of Tegic

When edit mode is finished, all words in the editor are registered in User Dictionary of Tegic.

Text Input

To switch On/Off T9 mode, press .







T9® Text Input

Using this mode of text input dramatically reduces the number of key presses required:

Press a key once for any letter you require on that key. The desired letter may not be displayed. Continue pressing other keys until the end of a word is reached; then check that the word has been typed correctly before continuing on to the next word. If the combination of letters typed has produced a word which is not the one you require, press  repeatedly until the correct word is displayed. Continue to the next word.

Example of Text Input in T9 Mode

To type a new message, follow these steps:

1. At the beginning of a new message press and hold  (Clear) to delete previous text, if necessary.
2. Press  to change letter case, if necessary
3. Press     "Call" is displayed.

Note that the displayed words change as you type, always type to the end of the word before editing.

T9® Languages can be selected from T9 Input -see "Setting T9 Text Input" on page 30.

If the word you require is not in the internal dictionary then it should be entered using the Multi tap (ABC) mode.

Other Text Modes

Select text mode (displayed in Information area on screen)

Multi tap mode (Abc, ABC or abc):

Each time a key is pressed in quick succession it displays the next character available on that key. Releasing the key or pressing another key enters the character displayed. The cursor moves to the next position.

In T9 (Abc) or Multi tap (Abc) mode, the first entered letter in a sentence is in upper case.

Phone Option Menu Structure

Phone Option

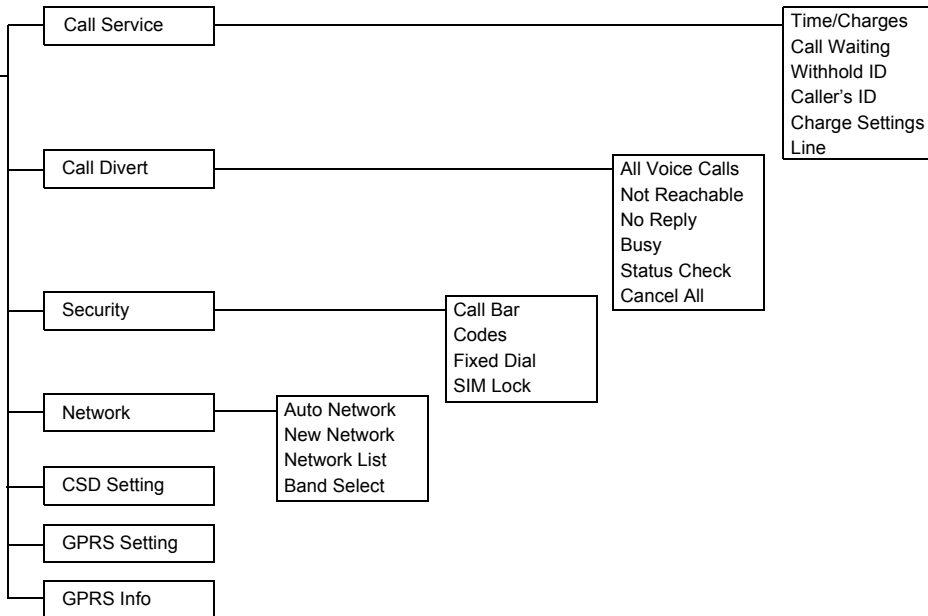

Phone Option

Call Service

The duration of the **Last Call** and **All Voice Calls** will be displayed. When the **Max Cost** is on, the remaining units will be displayed.

Viewing Time/Charges

From **Phone Option** menu

- 1 **Call Service** > **Time/Charges** (Select)
- 2 required service **Last Call**, **All Voice Calls** or **Cost Left** (Select)

Last Call	Display the duration of Last Call
All Voice Calls	Display the sum of the duration for the all voice calls
Cost Left	When Max Cost is on, display the remaining units. For setting the Max Cost , please refer to "Setting the Maximum Cost:" on page 60.

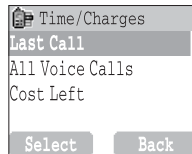

If **Call Waiting** is switched on, a second call can be received.

Setting Call Waiting

From **Phone Option** menu

- 1 **Call Service** > **Call Waiting** (Select)
- 2 **Set** (Select)

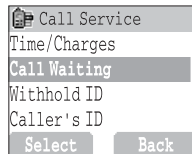

Withhold ID allows you to prevent showing your name and/or number to your calling party. **Caller's ID** allows to display Caller's name and/or number on your display.

Withhold ID / Caller's ID

From **Phone Option** menu

- 1 **Call Service** (Select)
- 2 **Withhold ID** or **Caller's ID** (Select)

NOTE: When checking the status the phone must be registered with a network.

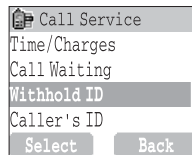

Firstly, Personal rate must be entered. This is the cost that the Service Provider charges for one unit of call time.

NOTE: Charge Setting is SIM dependent.

Charge Settings.....

Setting Currency:

From **Phone Option** menu

- 1 **Call Service > Charge Settings** (Select)
- 2 **Currency** (Select)

Current Setting is displayed

- 3 (Set) > Enter PIN2 code (OK)
- 4 Enter currency units (max.3 characters) (OK)

Setting Personal Rate:

From **Phone Option** menu

- 1 **Call Service > Charge Settings > Personal Rate** (Select)
- 2 (Set)

- 3 Enter PIN2 code (OK)
- 4 Press required personal rate (OK)

NOTE: When you set the unit price, you will be asked to enter your PIN2.

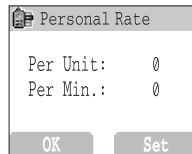

This function allows you to pre-set the maximum cost of calls allowed.

Setting the Maximum Cost:

From **Phone Option** menu

- 1 **Call Service** > **Charge Settings** (Select)
- 2 **Max Cost** (Set)
 - Current setting is displayed.
- 3 (Edit) > Enter PIN2 code (OK)
- 4 (Set) > **On** (Select)
- 5 Enter **Credit Limit** > (OK)

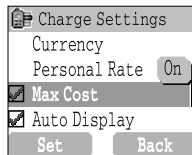

NOTE: The duration of one unit may vary during the day, peak and off-peak times. Call charges can be calculated accordingly. However, the call charge information may not give an accurate reflection of the actual tariffs charged by your Service Provider.

Setting Auto Display:

From **Phone Option** menu

- 1 **Call Service** > **Charge Settings** (Select)
- 2 **Auto Display** (On/off)

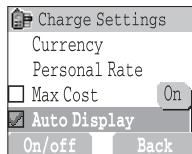

This menu is selectable only if your SIM supports CPHS and Line 1/2.

NOTE: This function is SIM dependent.

Setting Phone Line.....

From **Phone Option** menu

- 1 **Call Service** > **Line** (Select)
- 2 **Line 1/Line 2** (Select)







Call Divert

Voice calls can be diverted using different situations and to different numbers.

For example, you may wish voice calls to be diverted to voicemail box when the phone is switched off.

Setting Call Divert.....

From **Phone Option** menu

- 1  **Call Divert**  (Select)
- 2  Select the circumstances to initiate the divert  (Select)
- 3  required operation from **Set**, **Clear**, or **Check Status**  (Select)
- 4 Enter phone number to divert to 

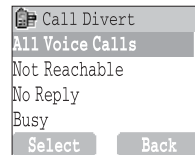

- When a divert situation is enabled the divert icon (↵) is displayed.
- When updating or checking the status of **Call Divert** the phone must be registered with a network. (↑)

All Voice Calls	Divert all incoming voice calls
Not Reachable	When phone is disconnected, divert incoming voice calls
No Reply	If call is not answered, divert incoming voice calls
Busy	When a call is in progress, divert incoming voice calls
Status Check	Check the current Call Divert status
Cancel All	Cancel all Call Divert settings

Call Barring restricts certain outgoing and/or incoming calls using a password supplied by your service provider. When updating/checking the status of Call Bar the phone must be registered with a network.

Security

Setting Call Bar

From **Phone Option** menu

- 1 **Security > Call Bar** (Select)
- 2 required setting from the menus showing below (Set) or (Select)
- 3 required operation from **Set, Clear** or **Check Status** (Select)
- 4 Enter required password (Select)

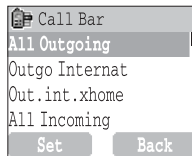

All Outgoing	All Outgoing calls are barred
Outgo Internat	International Outgoing calls are barred
Out.int.xhome	International Outgoing calls except home are barred
All Incoming	All Incoming calls are barred
When Roaming	All internal incoming calls when roaming outside the home PLMN
Status Check	Call bar status is displayed
Cancel All	Cancel all Call Bar settings
Password	Change Call Bar Password

Codes

The PIN protects your SIM against unauthorised use. If you enable the PIN, every time the phone is switched on you will be prompted to enter the PIN.

The PIN2 controls security for the Fixed Dial Store, Call Charge metering and Barred Dial.

If either PIN/PIN2 is entered incorrectly **3 times** the phone will be locked and you will need to enter the PUK/PUK2 code.

Contact the service provider for the PUK/PUK2 code

NOTE: To enter PUK code for PIN, enter **05# you will then be prompted to enter the PUK code, then follow the on-screen instructions.

To enter PUK2 code for PIN2, enter **052# you will then be prompted to enter the PUK2 code, then follow the on-screen instructions.

Change Phonecode.....

From **Phone Option** menu

- 1 **Security > Codes** (Select)
- 2 **Change Phonecode** (Select)
- 3 Enter New Phonecode (OK) x2

Enabling/Disabling the PIN.....

From **Phone Option** menu

- 1 **Security > Codes** (Select)
- 2 **PIN Control** (Set)
- 3 Enter PIN number (OK) x2

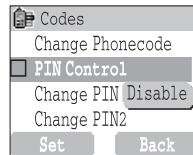

Changing the Security Code.....

From **Phone Option** menu

- 1 **Security > Codes** (Select)
- 2 **Change PIN or Change PIN2** (Select)
- 3 Enter the current code (OK)
- 4 Enter the new code (OK)
- 5 Enter the new code to verify (OK)

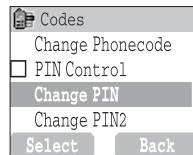





NOTE: If the PUK/PUK2 code is entered incorrectly 10 times, the phone will cease to operate permanently. All information stored in the SIM will be lost and the SIM will need to be replaced. Contact the service provider for more details.

Fixed Dial is a part of the Phonebook, but with added security. Only numbers that are in the Fixed Dial Store may be dialed.

Setting Fixed Dial

From **Phone Option** menu



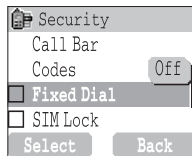

- 1  **Security**  (Select)
- 2  **Fixed Dial**  (Select)
- 3 Enter PIN2 code  (OK)



- > Any manually dialled phone numbers must be the same as the numbers in the Fixed Dial Store.
- > A phone number may be stored, edited or deleted. You will be prompted for your PIN2 code.

Setting SIM Lock

From **Phone Option** menu

- 1  **Security**  (Select)
- 2  **SIM Lock**  (Select)
- 3 Enter Phonecode  (OK)

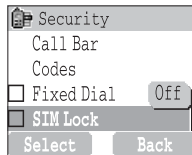





NOTE: You are advised to write down your Phonecode. In case you forget your phonecode, you will need to contact your service provider to unlock the SIM.

Network

Manually select a network that is available in your current location.

Network setting

From **Phone Option** menu

- 1  **Network**  (Select)
- 2  required option  (On/off) or  (Select)

Auto Network	Set "Auto Network" On or Off.
New Network	When "Auto Network" is on; Search an available network automatically. When "Auto Network" is off; Select a network manually
Network List	Create and edit a network list according to your preferences.
Band Select	Choose a network band: 900/1800, 900/1900, 900, 1800, 1900MHz.





CSD Setting

You need to complete CSD setting before setting your server.
- see "Server Setting" on page 40.

Connection Setting

You can set CSD setting when connecting to network.

From **Phone Option** menu

- 1  **CSD Setting**  (Select)
- 2  required setting  (Select)
- 3 when all the data are entered,  (Save)

Server Name	Enter Server Name
Call Type	Select ISDN or Analog
Dial Number	Enter the common numbers in Digital and Analogue.
Login Name	Enter Login ID
Password	Enter Password





You need to complete GPRS setting before setting your server.
- see "Server Setting" on page 40.

GPRS Setting

Connection Setting

You can set GPRS setting when connecting to network.

From **Phone Option** menu

- 1  **GPRS Setting**  (Select)
- 2  required setting  (Select)
- 3 when all the data are entered,  (Save)





- When GPRS setting is completed, the GPRS icon (**GPRS**) is displayed.

Server Name	Enter Server Name
GPRS APN	Enter Access Point Name
Login Name	Enter Login ID
Password	Enter Password
Authentication	Select Active or Deactive

GPRS Info

Viewing GPRS Information.....

From **Phone Option** menu

- 1  **GPRS Info**  (Select)
- 2 To reset GPRS Info;
 (Reset) >  (Yes)

Applications Menu Structure

Applications

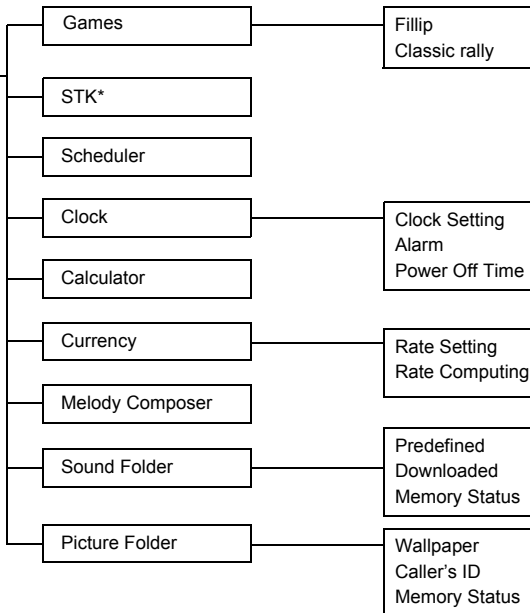

***NOTE:** STK (SIM Tool Kit) is SIM dependent

Applications

Games

From **Applications** menu

- 1 **Games** (Select)
- 2 required game (Select).

• Please refer to “Games” on page 32.

STK (SIM Took Kit)

This function is SIM dependent.



Scheduler

The Scheduler can be used to register reminders for personal events as well as planning holiday periods. Set clock first.









In the Scheduler, you can store:

- Type** (Memo or Meeting)
- Description**
- Start Date**
- Start Time**
- End Date**
- End Time**

NOTE: Ensure that the setting of the Scheduler will not contravene any regulations whereby it may automatically power on when in an aircraft or medical facility, etc. - see "Important Information" on page 1.











Entering a Schedule

From **Applications** menu

- 1  **Scheduler**  (Select)
- 2  to select **Week** or **Month** format
- 3 To select a day, press numerical keys 2, 8, 4 and 6 to move the cursor \uparrow , \downarrow , \leftarrow and \rightarrow , or  to move the cursor \uparrow or \downarrow to set a day.  (Agenda)
- 4  **<New Entry>**  (Select)
- 5 Enter required information
- 6  (Save).

Viewing / Editing Scheduler

From **Applications** menu

- 1  **Scheduler**  (Select)
- 2  to select **Week** or **Month** format
- 3 When Month format is selected:
Select a day marked in blue by using the numerical keys (2, 8, 4 and 6)  (Agenda)
When Week format is selected:
Schedule icon(s) will be shown corresponding to a period of time selected by pressing .
(Period of time: 4=0:01-4:00, 8=4:01-8:00, 12=8:01-12:00, 16=12:01-16:00, 20=16:01-20:00, 24=20:01-0:00)
Select a day by using the numeric keys (2, 8, 4 and 6)  (Agenda)
- 4  required schedule  (View)
- 5 To return to the previous display,  (OK)
To edit,  (Edit) edit required information  (Save)

Before setting Time & Date, set Time Zone of your region or the city which has same time zone as your region. When travelling abroad, your home time can be changed to your destination time.

Clock

Time Zone Setting

From **Applications** menu

- 1 **Clock > Clock Setting > Time Zone** (Select)
- 2 required region (Select)
- 3 (Yes) or (No) to select **"Day Light Saving?"**
- 4 **"Set This City to Local"** (OK)
- 5 **"Success!"** (OK)

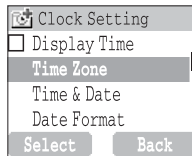

Time & Date Setting

From **Applications** menu

- 1 **Clock > Clock Setting > Time & Date** (Select)
- 2 (Set) enter the digits for the time (OK)

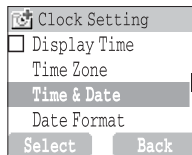

Time and date can be shown on the display in idle mode.

Time Display Setting

From **Applications** menu

- 1 **Clock > Clock Setting** (Select)
- 2 **Display Time** (On/off)

Display format for time and date can be selected.

Date Format/Time Format

From **Applications** menu

- 1 **Clock** > **Clock Setting** > **Date Format** or **Time Format** (Select)
- 2 required format (Select)

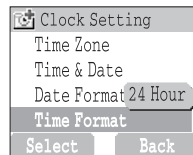

Alarm Setting

From **Applications** menu

- 1 **Clock** > **Alarm** (Select)
- 2 (Set) > Enter the digits for the time (24 hour clock) (OK)
- 3 Select from **Repeat Daily**, **Once** or **Disabled** (Select)
- 4 **"Alarm Time Has Been Updated!"** (OK)

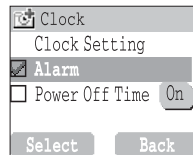

- Alarm set indicator appears on idle display.
- When the set time is reached, the alarm will sound. When in a call the phone will vibrate.

To end alarm:

Press any key or (Off)

OR (Pause) to pause the alarm and start again after 5 minutes

NOTE: Ensure that the setting of the Alarm will not contravene any regulations whereby it may automatically power on when in an aircraft or medical facility etc. - see "Important Information" on page 1.

The phone can be set to turn itself off automatically at a specified time using the Power Off feature. The procedure for setting/adjusting the Power Off automatically is similar to the setting of Alarm.

Power Off Time

From **Applications** menu

- 1 **Clock** > **Power Off Time** (Select)
- 2 Enter the digits for the time (24 hour clock) (OK)
- 3 Select from **Repeat Daily**, **Once** or **Disabled** (Select)
- 4 "Power Off Time Setting Updated!"

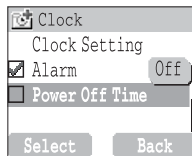

Calculator

The four function calculator will enable the user to perform simple arithmetic calculations (addition, subtraction, multiplication and division).

From **Applications** menu

- 1 **Calculator** (Select)
- 2 Enter a number (maximum 7 digits) and it will be displayed on the upper right of the display. When a decimal point is required, press $\# \frac{\circ}{x}$, when a minus sign is needed press \ast .
- 3 **⊕** to select the arithmetic operation
- 4 Enter a number (maximum 7 digits) and it will be displayed next to the operation symbol. If **⊕** is used to select another arithmetical operation to perform, an intermediate calculation will be performed and the result displayed on the top line.
- 5 **(=)** to calculate

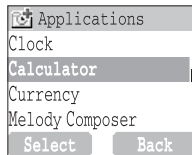







Currency

The currency convertor enables you to convert from/to a home currency using a conversion rate that you enter.

Setting the currency value.....



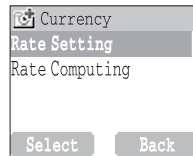

From **Applications** menu

- 1  **Currency**  (Select)
- 2  **Rate Setting**  (Select)
- 3 On the right side of the screen, enter your home currency rate to the currency which you want to convert with  (OK)
- 4  (Save)



Rate Computing.....

From **Applications** menu

- 1  **Currency**  (Select)
- 2  **Rate Computing**  (Select)
- 3 Enter the amount of currency which you want to convert into your home currency  (Convert)

Melody Composer

Please refer to "Composing a Melody" on page 24.











The Sound Folder contains predefined sound files and any downloaded sound files. You can play the sound and set one as your Ringtone.

The memory status is dependant on file sizes stored in the Melody Composer, Picture Folder and Sound Folder.

Sound Folder





Setting RingTone:

From **Applications** menu

- 1  **Sound Folder**  (Select)
- 2  **Predefined or Downloaded**  (Select)
- 3  required sound  (Menu)
 - To see the information of the selected RingTone,  **Info**  (Select)
 - To return to the previous menu,  (OK)
- 4  **Set to Ringtone**  (Select)

Viewing Memory Status:

From **Applications** menu

- 1  **Sound Folder**  (Select)
- 2  **Memory Status**  (Select)
 - **Free Space** and **Total Used** are displayed.
 - To return to the previous menu,  (OK)

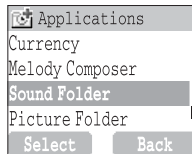

Picture Folder

You can find lists of predefined pictures and downloaded pictures in both Wallpaper folder and Caller ID folder. You can view those pictures, and also set one of them for the idle screen.

The memory status is dependant on file sizes stored in the Melody Composer, Picture Folder and Sound Folder.

Setting Wallpaper:

From **Applications** menu

- 1 **Picture Folder** (Select) > **Wallpaper** (Select)
- 2 **Predefined or Downloaded** (Select)
- 3 required picture (Menu)
 - To see the large picture, **View** (Select)
 - To return to the previous menu, **(Back)**
- 4 **Set to Wallpaper** (Select)

Viewing Picture of Caller's ID:

From **Applications** menu

- 1 **Picture Folder** (Select) > **Caller's ID** (Select)
- 2 **Predefined or Downloaded** (Select)
- 3 required picture (Menu)
- 4 **View or Info** (Select)
 - To return to the previous menu, **(Back)**

Viewing Memory Status:

From **Applications** menu

- 1 **Picture Folder** (Select)
- 2 **Memory Status** (Select)
 - **Free Space** and **Total Used** are displayed.
 - To return to the previous menu, **(OK)**

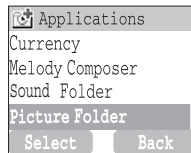

Records Menu Structure

Records

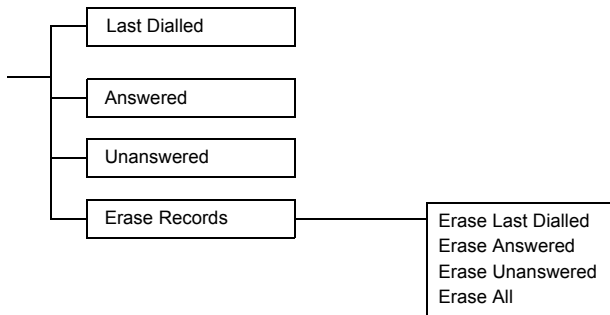

Records

If Caller Identification is known, caller's phone number, for an answered call will be stored in the **Answered menu** and an unanswered call will be stored in the **Unanswered menu**.

Calling for the Last Dialed/Answered/Unanswered number

From **Records** menu

- 1 Choose one menu from **Last Dialed**, **Answered** or **Unanswered**

(Select)

- 2 required phone number (or name) you wish to redial .

OR

In idle, to view the last dialed numbers directly.

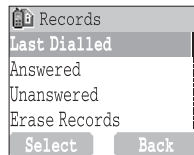

To save a record in Phonebook:

After selecting desired number,

(Menu) > **Save** (Select) > **SIM Phonebook** or **Mobile Phonebook** (Select)

Enter Name and Phone number (Save).

NOTE: When the store is full the next phone number will overwrite the oldest.

Erasing Records.....

From **Records** menu

- 1 **Erase Records** (Select)

- 2 Choose one menu from **Erase Last Dialed**, **Erase Answered**, **Erase Unanswered** or **Erase All** (Select).

- 3 (Yes)

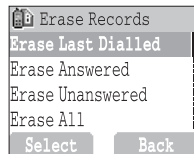

Troubleshooting

Should any problem persist contact your dealer.

Problem	Cause	Remedy
Phone will not switch on.	_____	Check that the battery is fully charged and correctly connected to the phone.
Extremely short battery life for a new battery.	The network you are using and the condition of the battery can affect battery life.	_____
Short battery life for an old battery.	The battery has worn out.	Replace with a new fully charged battery.
The charging indicator does not light, the battery level indicator does not appear and the phone cannot be switched on when charging.	The battery is not attached to the phone or when the battery has been deeply discharged the phone will take a short time until the indicator lights.	Leave the phone charging the battery for a few minutes before the indicator is lit and attempting to switch it on.
Battery fails to charge.	The battery is not attached to the phone.	Ensure the battery is fitted to the phone prior to commencing charging.
	Battery has been connected to the phone after the Fast Travel Charger has been switched on.	
Calls cannot be made.	The phone is locked.	Unlock the phone.
	Outgoing calls are barred.	Disable the outgoing call barring or barred dial.
	The phone is not registered to a network.	Move to a coverage area and operate your phone after it has registered with a network.

Problem	Cause	Remedy
Calls cannot be made from Fixed Dial Store.	_____	Check whether your SIM supports Fixed Dial. Check if the Fixed Dial is switched on. Check whether the phone number is stored in the Fixed Dial.
Calls cannot be received.	The phone is not switched on.	Switch the phone on.
	Incoming calls are barred.	Disable the incoming call barring.
	The phone is not registered to a network.	Move to a coverage area and operate your phone after it has registered with a network.
Emergency calls cannot be made.	You are not in a GSM coverage area.	Check that the antenna symbol S is displayed – move to a coverage area and operate your phone when the antenna symbol is displayed.
Phone numbers cannot be recalled from Phonebook.	The phone is locked.	Unlock the phone.
	Phone number has been restricted.	Switch off restriction.

Glossary of Terms

APN	Access Point Name. Directs the user to the gateway or the required service.
CHAP	Challenge Handshake Authentication Protocol. A security feature for the GPRS network.
CSD	Circuit Switched Data. A communication method used to transmit data over telephone connections.
DTMF Tones	Dual Tone Multi-Frequency tones allow you to communicate with computerised phone systems, voice mailboxes, etc.
EMS	Enhanced Messaging Services. One of the mail systems which use the cellular phone, and service by which data of e-mail of the text, etc. can be transmitted and received.
GPRS	General Packet Radio Service. A GSM transmission technique that transmits and receives data in packets rather than setting up a continuous channel. It makes very efficient use of available radio spectrum and users pay only for volume of data sent and received.
GSM	Global System for Mobile communications. The name given to the advanced digital technology that your phone uses.
Network Operator	The organization responsible for operating a GSM network.
PAP	Password Authentication Protocol. A security feature in the GPRS network.
Password	Used for the control of Call Bar. Supplied by your service provider.
PIN	Personal Identification Number used for SIM security. Supplied by your service provider. If the PIN is entered incorrectly 3 times, the PIN will be blocked.
PIN2	Personal Identification Number used for the control of Fixed Dial Store and Call Charge metering. If the PIN2 is entered incorrectly 3 times, the PIN2 will be blocked.

PUK/PUK2	PIN/PIN2 Unlocking Key. Used to unblock the PIN/PIN2. Supplied by your service provider. If the PUK/PUK2 is entered incorrectly 10 times, the PUK/PUK2 will be blocked.
Registration	The act of locking on to a GSM/GPRS network. This is usually performed automatically by your phone.
Roaming	The ability to use your phone on networks other than your Home network.
Service Provider	The organization responsible for providing access to the GSM/GPRS network.
SIM	Subscriber Identity Module. A small smart-card which stores unique subscriber and user-entered information such as Phonebook and Short Messages. Supplied by your service provider.
SMS	Short Message Service. A basic mail system used for cellular phones. This service allows sending/receiving short text messages.
WAP	Wireless Application Protocol. The communication standard which enables you to download resources from the Internet to your phone.

Specifications

Bands Supported	GSM 900 Class 4 GSM1800 Class 1 GSM1900 Class 1
Standby Time (hrs)*	80 – 200
Talk Time (hrs)*	2.5 – 6
Temperature Range	
Charging	+5°C – +35°C
Storage	-20°C – +60°C
Weight	74 g (including battery)
Dimensions	
Height	80 mm
Width	43 mm
Depth	19 mm
Supply Voltage	780 mAh Li-ion
Antenna	Fixed
Charge Time**	Up to 165 Min
SIM Type	3 V only
Phonebook Memory	250 entries + SIM
Animation Themes	2
User Composed Melody	5
Games	2

Backlight Colours	1 (White)
Ring Tones	Preset: 20 (Varies depending on Data Folder)
Scheduler	Up to 50 entries
Alarms	1
Graphics Formats Supported	GIF89a, BMP, WBMP, PNG, WPNG, JPEG
Maximum Graphics Size	W128 x H80 pixels (4096 CSTN colours)

NOTE: Specifications are subject to change without notice.

***NOTE:** Talk and Standby time depend on network conditions, SIM usage and battery condition.

****NOTE:** Charging time depends on usage and battery condition.

Accessories

Li-Ion Battery (EB-BSG50)



Double your talk time by having a spare battery.

Fast Travel Charger (EB-CAD55UK)



Carry a lightweight portable charger wherever you go to ensure you always have power to talk.

Fast Travel Charger (EB-CAD55EU)



How to Identify a Genuine Panasonic Accessory

Panasonic produces some of the most advanced mobile phones available. So, as you'd expect from this class leader, the range of accessories are second to none. Most genuine Panasonic accessories will have a label showing an "EB-XXX00" model number.

NOTE: Accessories are subject to change without notice.

Personal Settings

Item	Provisioning Information Setting No. 1	Provisioning Information Setting No. 2	Provisioning Information Setting No. 3	Provisioning Information Setting No. 4	Provisioning Information Setting No. 5
IP Port					
Home page					
Gateway IP					
Port (Secure / Non-Secure)					
Data connections					
Circuit Switched (GSM)					
Name					
Account					
Password					
Call type					
Phone no.					
Idle timer					
CSD Setting					
Packet Switched (GPRS)					
Name					
Account					
Password					
Apn name					
Auth type Normal / Secured / None (PAP) (CHAP)					

Licensing

CP8 Patent

© Panasonic Mobile Communications Co., Ltd. 2003

Information in this document is subject to change without notice. No part of these instructions may be reproduced or transmitted in any form or by any means without obtaining express permission from Panasonic Mobile Communications Co., Ltd.

CE0700

Tegic

T9® is a trademark of Tegic Communications Inc. T9R Text Input is licenced under one or more of the following: U.S. Pat. Nos. 5,818,437, 5,953,541, 5,187,480, 5,945,928 and 6,011,554; Canadian Pat. No. 1,331,057; United Kingdom Pat. No. 2238414B; Hong Kong Standard Pat. No. HK0940329; Republic of Singapore Pat. No. 51383; Euro. Pat. No. 0 842 463 (96927260.8) DE/DK, FI, FR, IT, NL, PT.ES, SE, GB; and additional patents are pending worldwide.

OpenWave

OpenWave is a pioneer in the mobile data transfer industry, supplying voice and data revenue to the mobile communications sector.



Index

A

Accessories	83
Access to Shortcuts	30
Activating a profile	20
Alarm Setting	71
Answering Calls	15
Any Key Answer	29
Applications	68
Auto Answer	29
Auto capital change.....	55
Auto Display	53

B

Back to the menu display	9
Brightness	22
Bookmarks	42
Broadcast	51
Browser	40
Browsing Bookmark	42
Browsing the Phone Book	35

C

Calculator	72
Call Divert	61
Call Service	58
Calling for the Last Dialed/Answered/ Unanswered number	77
Care and Maintenance	4
Changing the Language	28

Changing the Ring Tone	22
Changing the Security Code	63
Changing Alert Type	23
Changing the Volume	22
CHAP	80
Charge Settings	59
Charging the Battery	6
Classic rally	32
Clock	70
Codes	63
Composing a Melody	24
Connection Setting	65
Contents	i
Creating a New Short Text Message	45
CSD Settings	65
Currency.....	73

D

Date Format/Time Format	71
Desktop Handsfree	16
Disabling Key Guard	43
Display	8,26
Displaying Menu	12
DTMF Tones	17,80

E

Earpiece Volume	13
Editing profiles	20
Editing User Messages	28,46

Emergency Call	14
Enabling/Disabling the PIN	63
Entering a Schedule	69
Entering to the Menu Display	9
Erasing Records	77
European Union - RTTE	3
EU Warranty	90

F

Fillip	32
Fitting, and Removing the Battery	5
Fitting, and Removing the SIM	5

G

Games	32,68
Getting Started	5
Glossary of Terms	80
GPRS	80
Group Settings	36
GSM	80

H

Hot Key Dial	38
--------------------	----

I

Important Information	1
In-Call Options	16
Incoming Call While in a Call	18
International Dialling	14

K

Key Guard	43
-----------------	----

Key Tone	21
Key Operation	32
Keys & Displays	7
Keys	7

L

Last Number Dialling	14
Licencing	85
Long Press	11
Low Battery Warning	6

M

Making a Call by Using Hot Key Dial	38
Making a Second Call	18
Making Calls	13
Melody Composer	73
Memory Status	37
Menu Display	9
Messages	45
My Numbers	37
My Phone	20
My Phonebook	30, 38

N

Network	65
Network Operator	80
Network setting	65

O

Operation of Battery Level Indicator	6
Options	50
Options in Phone Book	35

Other Text Mode 56

P

PAP 80
 Password 80
 Pause Dial 17
 Personal Settings 84
 Phone Basics 12
 Phone Book 34
 Phone ON/OFF 12
 Phone Option 58
 Phonebook Dialling 13
 Picture Folder 75
 PIN 80
 PIN2 81
 Power Off Time 72
 Profile Setting 20
 PUK/PUK2 81

R

Rate Computing 73
 Reading a Received Message 47
 Records 77
 Registration 81
 Reset Defaults 29
 Ring Volume 20
 Roaming 81

S

SAR 3
 Safety Considerations 1
 Scheduler 69

Security 62
 Selecting Games 32
 Server Setting 40
 Service Provider 81
 Setting Any Key Answer 29
 Setting Auto Answer 29
 Setting Auto Display 53
 Setting Bookmark 42
 Setting Brightness 27
 Setting Call Bar 62
 Setting Call Divert 61
 Setting Call Waiting 58
 Setting Colour Themes 27
 Setting Display Animation 26
 Setting Display Contrast 27
 Setting Fixed Dial 64
 Setting Greeting 26
 Setting Hot Key Dial 38
 Setting Broadcast 51
 Setting Key Guard 43
 Setting Key Tone 23
 Setting Language 52
 Setting My Numbers 37
 Setting Options 50
 Setting Personal Rate 59
 Setting Phone Line 60
 Setting Shortcuts 30
 Setting SIM Lock 64
 Setting SIM or Mobile Phonebook 30
 Setting T9 Text Input 30
 Setting the currency value 73
 Setting the Maximum Cost 60

Setting the Message Centre Number	45
Setting Topic	50
Setting Wallpaper	26
Setting Warning Tone	23
Shift mode change.....	55
Shortcuts	30
Short press	11
Shortcut from Idle Screen	11
SIM	81
SMS	45
Sound Folder	74
Sound Setting	22
Specifications	82
Standard Dialling	13
Starting Games	32
Status Icons	8
Storing	34
Storing a Number in Mobile Phonebook.....	34
Storing a Number in SIM	34
Symbols Used in the Manual.....	9

T

Tegic.....	55
T9 Text Input	56
Text Entry	54
Text Input	55
Time & Date Setting	70
Time Display Setting	70
Time Zone Setting	70
Troubleshooting	78

U

User Messages	28
---------------------	----

V

Vibrator	21
Viewing	35
Viewing / Entering Scheduler	69
Viewing Memory Status	37, 50
Viewing Message Lists in Archive	49
Viewing Message Lists in Outbox	48
Viewing My Numbers	37
Viewing Time/Charges	58

W

WAP	81
WAP Activating	41
Warning Tone	21
Withhold ID / Caller's ID	59

EU Warranty

EU/EEA – Wide guarantee is applicable in the EU/EEA and Switzerland.

Panasonic GSM European Service Guarantee Conditions

Dear Customer,

Thank you for buying this Panasonic digital cellular telephone. The Panasonic GSM European Service Guarantee only applies while travelling in countries other than where the product was purchased. Your local guarantee is applicable in all other cases. If your Panasonic GSM telephone requires service while abroad, please contact the local service company shown on this document.

The Guarantee

The applicable period of the European wide guarantee for GSM is generally 12 months for the main body and 3 months for the rechargeable battery. With respect to a product used in a country other than a country of purchase, notwithstanding what is stated in the conditions below, the customer will benefit, in that country of use, from these guarantee periods of, respectively, 12 and 3 months, if these conditions are more favourable to him than the local guarantee conditions applicable in such country of use.

Conditions of Guarantee

When requesting guarantee service the purchaser should present the warranty card together with proof of purchase, to an authorised service centre.

The guarantee covers breakdowns due to manufacturing or design faults; it does not apply to other events such as accidental damage, however caused, wear and tear, negligence, adjustment, modification or repair not authorised by us.

Your sole and exclusive remedy under this guarantee against us is the repair, or at our option the replacement, of the product, or any defective part or parts. No other remedy, including, but not limited to, incidental or consequential damage or loss of whatsoever nature shall be available to the purchaser.

This is in addition to and does not in any way affect any statutory or other rights of consumer purchasers. This guarantee applies in countries shown on this document at the authorised service centres detailed for that country.

UK

Service Centres in England
Tel. +44 8705 159159

IRL

Service Centres in Ireland
Tel. +353 1 2898333

D

Panasonic Service Center Dresden
SERKO GmbH
Großenhainer Straße 163
01129 Dresden
Tel. +49 (0)351/ 85 88 477

Panasonic Service Center Cottbus
Petsch Kundendienst GmbH
Am Seegraben 21
03058 Gross-Gaglow
Tel. +49 (0)355/ 58 36 36

Panasonic Service Center Leipzig
KES Keilitz-Electronic-Service GmbH
Föppelstraße 19
04347 Leipzig
Tel. +49 (0)341/ 244 33 33

Panasonic Service Center Chemnitz
WPS Rundfunk- u. Fernsehservice GmbH
Fietzenstraße 16
09130 Chemnitz
Tel. +49 (0)371/ 40 10 359

Panasonic Service Center Berlin
SERKO GmbH
Schwedter Straße 34a
10435 Berlin
Tel. +49 (0)30/ 44 30 322

Panasonic Service Center Berlin
RUESS SYSTEMS
Thrasoltstraße 11
10585 Berlin
Tel. +49 (0)30/ 342 2013

Panasonic Service Center Rostock
warnow electronic service gmbh
An der Jägerbäk 2
18069 Rostock
Tel. +49 (0)381/ 82 016

Panasonic Service Center Hamburg
ELVICE Service GmbH
Spaldingstraße 74
20097 Hamburg
Tel. +49 (0)40/ 23 08 07

Panasonic Service Center Rendsburg
FERNSEH-DIENST B&W Service GmbH
Kieler Straße 41
24678 Rendsburg
Tel. +49 (0)4331/ 14 11-0

Panasonic Service Center Bremen
COM Elektronik Service GmbH
Rübekamp 50
28219 Bremen
Tel. +49 (0)421/ 691 80 69

Panasonic Service Center Hannover
COM Elektronik Service GmbH
Vahrenwalder Straße 311
30179 Hannover
Tel. +49 (0)511/ 37 27 91

Panasonic Service Center Magdeburg
SERKO GmbH
Ebendorfer Chaussee 47
39128 Magdeburg
Tel. +49 (0)391/ 289 90 69

Panasonic Service Center Düsseldorf
VTH GmbH
Kölner Straße 147
40227 Düsseldorf
Tel. +49 (0)211/ 77 90 25

Panasonic Service Center Essen
Bernd van Bevern GmbH
Heinrich-Held-Straße 16
45133 Essen
Tel. +49 (0)201/ 84 20 220

Panasonic Service Center Osnabrück
Petsch Kundendienst GmbH
Pagenstecherstraße 75
49090 Osnabrück
Tel. +49 (0) 541/ 68 038

Panasonic Service Center Wiesbaden
J. Hemmerling - VAD GmbH
Ostring 7
65205 Wiesbaden
Tel. +49 (0)6122/ 90 91 10

Panasonic Service Center Mannheim
N. Schaaf
Reichenbachstraße 21-23
68309 Mannheim
Tel. +49 (0)621/ 72 787-0

Panasonic Service Center Stuttgart
Hans Beck
Friedrich-List-Straße 38
70771 Leinfelden-Echterdingen
Tel. +49 (0) 711/ 94 701-0

Panasonic Service Center Reutlingen
Herbert Geissler
Lichtensteinstraße 75
72770 Reutlingen
Tel. +49 (0)7072 / 92 96-0

Panasonic Service Center München
G.Berghofer & W.Kaller GmbH
Helene-Wessel-Bogen 7
80939 München
Tel. +49 (0)89/ 318 907-0

Panasonic Service Center Augsburg
Klaus Bienek
Affinger Straße 4
86167 Augsburg
Tel. +49 (0)821/ 70 70 75

Panasonic Service Center Nürnberg
Herbert Geissler GmbH
Friedrich-Ebert-Straße 21
90537 Feucht
Tel. +49 (0)9128/ 70 67-0
vPanasonic Service Center Eisenach
Blitz Electro-Electronic-GmbH
Bahnhofstraße 17
99817 Eisenach
Tel. +49 (0)3691/ 29 29 42 8

A

Service-Fentren in Österreich
Fa. Frisch
Lokalbahnweg 12
A-4060 Leonding
Tel. +43 (0)732 676 961

FR

CETELEC

FI de la Delorme
5 Avenue Paul héroult
13015 MARSEILLE
Tél. : 04 96 15 77 77
Tél. : 04 91 58 07 55

CORDON Electronique

BP 460
FI Taden
22107 DINAN CEDEX
Tél. : 02.96.85.82.20
Fax : 02.96.85.82.21

EASY REPAIR

26 rue des Cosmonautes
31400 Toulouse
Tél. : 05.62.71.48.14
Fax : 05.62.71.48.15

EASY REPAIR

22 boulevard des Brotteaux
69006 Lyon
Tél. : 04.72.83.02.02
Fax : 04.78.52.40.38

ELECTRONIQUE SERVICE

Avenue Figuières
FAC Font de la Banquière
34970 LATTES
Tél. : 04.67.15.96.30
Fax : 04.67.20.04.72

GENERAL ELECTRONIQUE

16 rue Joseph Cugnot
F.I. Bracheux
60000 BEAUVAIS
Tél. : 03.44.89.79.00
Fax : 03.44.05.16.96

Négoce Technique etMaintenance

40 boulevard Bessières
75017 PARIS
Tél. : 01.44.85.21.66
Fax : 01.42.29.60.05

S.B.E.

F.I. de la Liane
BP 9
62360 SAINT LEONARD
Tél. : 03.21.10.10.21
Fax : 03.21.80.20.10

NL

Service-centra in Nederlands

Panasonic-Centre Nederland

(Servicom bv)
P.O Box 16280
2500 BG
Den-Haag
Nederland
Tel. +31 703314314

Fonweg 60
2516 BM
Den-Haag
Nederland
Tel. +31 703314314

I

Per I Centri Assitenza in Italia
 Servizio Clienti
 Tel. +39 02/ 67072556

E

Panasonic España, S.A.
 Servicio de Atención a Usuarios:
 Tel: 902 15 30 60

DK

For nærmeste servicecenter ring Panasonic Danmark
 Tel. +45 43 20 08 50

S

Firmor I Sverige
 Komrep
 Rosenlundsgatan 4
 411 20 Göteborg
 Tel. +46 031-173354
 Signalstyrkan
 Kungsholmstorg 4
 104 22 Stockholm
 Tel. +46 08-6542500
 CR service
 Industribyn 3
 232 37 Malmö
 Tel. +46 040-430030

SF

Huoltokeskukset Suomessa:

KAUKOMARKKINAT OY PANASONIC-HUOLLOT Kutojantie 4
 02630 Espoo
 Puh. +358 09 521 5151 Huolto
 Puh. +358 09 521 5155 Varaosat Ja Tarvikkeet

SETELE OY
 Vanha Viertotie 7
 00300 Helsinki
 Puh. +358 09 549100

PLAY-SHOP SERVICE Keskuskatu 3
 00100 Helsinki
 Puh. +358 09 27053626

MEGAFIX KY
 Louhenkatu 9
 74100 Iisalmi
 Puh. +358 017 14631

T: MI.M.HAAPOJA
 Miilukatu 7
 40320 Jyväskylä
 Puh. +358 014 677121

OUTOKUMMUN PUHELIN Pohjoisahonkatu 9
 83500 Outokumpu
 Puh. +358 013 562211

SETELE OY
 Rengastie 31
 60100 Seinäjoki
 Puh. +358 06 4148344

TURUN J-MARKKINAT OY Tuureporinkatu 6
 20100 Turku
 Puh. + 358 02 2332685

N

Servicesenter I Norge
Norsk Elektroniksenter
Fetveien 1
2007 Kjeller
Tlf: +47 63 80 45 00
vPanasonic Norge AS
Østre Aker vei 22
0508 Oslo
Tlf: +47 22 91 68 00

GR

ΕΥΡΩΠΑΪΚΑ ΚΑΤΑΛΟΓΟΓΡΑΦΗ
INTERTECH S.A.
International Technologies
Αδελφίδων 26, 167 77 ΕΛΛΗΝΙΚΟ
Ταχ. Θυρ.: 738 21, 167 10 ΕΛΛΗΝΙΚΟ
Τηλ. Κέντρι: (01) 9692.300
Ότιδήποτε χρειάζεται να αγοράστεί:
Κ. Καραμανλή 11, 54638 ΘΕΣΣΑΛΟΝΙΚΗ
Τηλ. Κέντρο: (031) 245.840-3

P

Centros de Assistência em Portugal
PAPELACO, S.A.
Vale Paraiso - Ferreiras
8200 ALBUFEIRA
ALGARVE
Tel. +351 89 589960

PAPELACO, S.A.
Largo de Santos, 9
1200 LISBOA
Tel. +351 1 3970539

PAPELACO, S.A.
Largo do Tribunal, Lote 11
2400 LEIRIA
Tel. +351 44 28071
vPAPELACO, S.A.
Rua Cidade de Santos, 31R/C
9000 FUNCHAL
MADEIRA
Tel. +351 91 231523

PAPELACO, S.A.
Rua do Outeiro,
Lote 25 - Gemunde
4470 MAIA
PORTO
Tel. +351 2 944 0354/9

PAPELACO, S.A.
Rua Major Leopoldo da Silva,
Lote 3
3500 VISEU
Tel. +351 32 424771

B

Centres de service après-vente en Belgique
BROOThAERS
Hoevelei 167
2630 AARTSELAAR
Tel. +32 03/887 06 24

HENROTTE
Rue du Campinaire 154
6240 FARCENNES
Tel. +32 071/39 62 90

PIXEL VIDEOTECH
Rue St Remy 7
4000 LIEGE
Tel. +32 041/23 46 26

DELTA ELECTRONICS
Rue P.d'Alouette 39
5100 NANINNE
Tel. +32 081/40 21 67

ELEKSERVICE FEYS
Houthulstseweg 56
8920 POELKAPELLE
Tel. + 32 057/48 96 37

AVS WAASLAND
Lavendelstraat 113
9100 ST NIKLAAS
Tel. +32 03/777 99 64

A.V.T.C SA
Kleine Winkellaan 54
1853 STROMBEEK-BEVER
Tel. + 32 02/267 40 19

RADIO RESEARCH
Rue des Carmélites 123
1180 BRUXELLES
Tel. +32 02/345 68 56

VIDEO TECHNICAL SERVICE
Av. du Roi Albert 207
1080 BRUXELLES
Tel. +32 02/465 33 10

SERVICE CENTER
Kapellestraat 95
9800 DEINFE
Tel. +32 09/386 67 67

TOP SERVICE
Westerloseweg 10
2440 GEEL
Tel. +32 014/54 67 24

TELECTRO SC
Quai des Ardennes 50
4020 Liège
Tel. +32 041/43 29 04

L

Centres de service après-vente au Luxembourg

NOUVELLE CENTRAL RADIO
Rue des Jones 15
L - 1818 Howald
Luxembourg - Grand Duché
Tel. +32 40 40 78

CH

Jonh Lay Electronics AG
Littauerboden
6014 Littau
Phone: +41 41 259 9090 Fax: +41 41 252 0202

TR

TEKOFAKS ISTANBUL CENTRE OFFICE
KAĐITHANE CADDESİ SEVÝLEN SOKAK NO. 58 80340 ÇADLAYAN-
ISTANBUL

Tel: 90-212-220 60 70 / 14 Lines

Fax: 90-212-220-60 94

ANKARA BRANCH OFFICE
GÜVEN MAH.FARABI SOKAK NO: 38/6 06690 KAVAKLIDERE-
ANKARA

Tel: 90-312-467 30 94/2 Lines pbx

Fax: 90-312 467 85 38

ÝSMÝR BRANCH OFFICE
CUMHURÝYET BULVARI NO:330 K.:6 D.:608 SEVÝL ÝP MERKEFÝ
35520 ALSANCAK-ÝFMÝR

Tel: 90-232-464 29 01 pbx

Fax: 90-232-422 67 44

BURSA BRANCH OFFICE
PEHREKÜSTÜ MAHLESÝ DURAK CADDESÝ NO.:7 BURSA

Tel: 90-224-225 10 46 pbx

Fax: 90-224-223 81 03

ADANA BRANCH OFFICE
REĐATBEY MAH.FUFULÝ CAD.GÜLEK SÝTESÝ A BLOK NO: 75b
01120 ADANA

Tel: 90-322-458 39 52 pbx

Fax: 90-322-453 21 32

TRABFON BRANCH OFFICE
MARAP CAD.MARAP APT.NO:51 D.:2 61200 TRABFON

Tel: 90-462-321 33 08

Fax: 90-462-326 37 78

ANTALYA BRANCH OFFICE
ALTINDAĐ MAH. 146 SOKAK ÖFKOÇ APT.NO:9/1-2A ANTALYA

Tel: 90-242-243 23 70 / 3 Lines

Fax: 90-242-243 23 72

DÝYARBAKIR BRANCH OFFICE
LÝSE CADDESÝ GÖKALP APT.NO: 18/A DÝYARBAKIR

Tel: 90-412-228 73 00

Fax: 90-412-223 59 00

EU/EEA – Wide Guarantee: Conditions applicable in any country other than the country of original purchase.

When the purchaser finds the appliance to be defective, he should promptly contact the proper sales company or national distributor in the EU/EEA country where this guarantee is claimed, as indicated in the "Product Service Guide" or the nearest authorised dealer together with this guarantee and proof of date of purchase. The purchaser will then be informed whether:

- (i) the sales company or national distributor will handle the repair service; or
- (ii) the sales company or national distributor will arrange for transportation of the appliance to the EU/EEA country where the appliance was originally marketed; or
- (iii) the purchaser may himself send the appliance to the sales company or national distributor in the EU/EEA country where the appliance was originally marketed.

If the appliance is a product model which is normally supplied by the sales company or national distributor in the country where it is used by the purchaser, then the appliance, together with this guarantee card and proof of date of purchase, should be returned at the purchaser's risk and expense to such sales company or distributor, which will handle the repair service. In some countries, the affiliated sales company or national distributor will designate dealers or certain service centres to execute the repairs involved.

If the appliance is a product model which is not normally supplied in the country where used, or if the appliance's internal or external product characteristics are different from those of the equivalent model in the country where used, the sales company or national distributor may be able to have the guarantee repair service executed by obtaining spare parts from the country where the appliance was originally marketed, or it may be necessary to have the guarantee repair service executed the sales company or national distributor in the country where the appliance was originally marketed.

In either case, the purchaser must furnish this guarantee card and proof of date of purchase. Any necessary transportation, both of the appliance and of any spare parts, will be at the purchaser's risk and expense, and there may be a consequent delay in the repair service.

Where the consumer sends the appliance for repair to the sales company or national distributor in the country of use of the appliance, the service will be provided on the same local terms and conditions (including the period of guarantee coverage) as prevail for the same model appliance in the country of use, and not the country of initial sale in the EU/EEA. Where the consumer sends the appliance for repair to the sales company or national distributor in the EU/EEA country where the appliance was originally marketed, the repair service will be provided on the local terms and conditions prevailing in the country of initial sale in the EU/EEA.

Some product models require adjustment or adaptation for proper performance and safe use in different EU/EEA countries, in accordance with local voltage requirements and safety or other technical standards imposed or recommended by applicable regulations. For certain product models, the cost of such adjustment or adaptation may be substantial and it may be difficult to satisfy local voltage requirements and safety or other technical standards. It is strongly recommended that the purchaser investigates these local technical and safety factors before using the appliance in another EU/EEA country.

This guarantee shall not cover the cost of any adjustments or adaptations to meet local voltage requirements and safety or other technical standards. The sales company or national distributor may be in a position to make the necessary adjustments or adaptations to certain product models at the cost of the purchaser. However, for technical reasons it is not possible to adjust or adapt all product models to comply with local voltage requirements and safety or other technical standards. Moreover, where adaptations or adjustments are carried out the performance of the appliance may be affected.

If in the opinion of the sales company or national distributor in the country where the appliance is used the purchaser has the necessary adjustments or adaptations to local voltage requirements and technical or safety standards properly made, any subsequent guarantee repair service will be provided as above indicated, provided the purchaser discloses the nature of the adjustment or adaptation if relevant to the repair. (It is recommended that the purchaser should not send adapted or adjusted equipment for repair to the sales company or national distributor in the country where the appliance was originally marketed if the repair relates in any way to the adaptation or adjustment.)

This guarantee shall only be valid in territories subject to the laws of the European Union and the EEA.

Please keep this guarantee with your receipt.

The Serial Number can be found on the outside of the phone under the battery. For your convenience we recommend that you note the following details as a record of your purchase.

Part Number	
Serial Number	
Dealer Name	
Purchase Date	